

ALL TRAFFIC DATA INC.

(916)771-8700

FAX 786-2879

Pacific

CITY OF ROCKLIN

File Name : F-Taylor-Rocklin Rd

Site Code : 00000000

Start Date : 10/4/2006

Page No : 1

Groups Printed- Unshifted

Start Time	TAYLOR RD. Southbound				ROCKLIN RD. Westbound				Northbound				Eastbound				Int. Total
	Right	Thru	Left	App. Total	Right	Thru	Left	App. Total	Right	Thru	Left	App. Total	Right	Thru	Left	App. Total	
07:00	3	81	28	112	35	8	54	97	51	50	2	103	7	11	4	22	334
07:15	0	75	40	115	28	18	59	105	86	66	2	154	7	26	6	39	413
07:30	4	115	56	175	21	10	67	98	129	64	1	194	4	29	8	41	508
07:45	4	103	51	158	32	6	69	107	120	88	2	210	8	18	3	29	504
Total	11	374	175	560	116	42	249	407	386	268	7	661	26	84	21	131	1759
08:00	5	86	46	137	21	23	90	134	108	70	8	186	16	40	1	57	514
08:15	6	100	30	136	25	32	144	201	139	67	14	220	15	66	10	91	648
08:30	7	99	17	123	36	15	88	139	91	61	4	156	7	15	4	26	444
08:45	5	91	28	124	33	10	73	116	90	83	2	175	5	20	4	29	444
Total	23	376	121	520	115	80	395	590	428	281	28	737	43	141	19	203	2050
16:00	5	112	31	148	43	40	149	232	122	127	5	254	7	19	8	34	668
16:15	8	108	28	144	42	33	118	193	123	93	9	225	9	21	6	36	598
16:30	5	136	40	181	41	29	135	205	118	98	14	230	7	23	4	34	650
16:45	2	136	30	168	48	51	130	229	134	107	8	249	9	19	7	35	681
Total	20	492	129	641	174	153	532	859	497	425	36	958	32	82	25	139	2597
17:00	10	113	22	145	76	30	164	270	127	130	11	268	3	44	10	57	740
17:15	4	129	30	163	56	38	166	260	130	108	8	246	4	27	13	44	713
17:30	7	112	23	142	47	22	139	208	134	88	5	227	1	16	6	23	600
17:45	7	81	24	112	47	44	118	209	113	84	7	204	2	19	9	30	555
Total	28	435	99	562	226	134	587	947	504	410	31	945	10	106	38	154	2608
Grand Total	82	1677	524	2283	631	409	1763	2803	1815	1384	102	3301	111	413	103	627	9014
Apprch %	3.6	73.5	23.0		22.5	14.6	62.9		55.0	41.9	3.1		17.7	65.9	16.4		
Total %	0.9	18.6	5.8	25.3	7.0	4.5	19.6	31.1	20.1	15.4	1.1	36.6	1.2	4.6	1.1	7.0	

Start Time	TAYLOR RD. Southbound				ROCKLIN RD. Westbound				Northbound				Eastbound				Int. Total
	Right	Thru	Left	App. Total	Right	Thru	Left	App. Total	Right	Thru	Left	App. Total	Right	Thru	Left	App. Total	
Peak Hour From 07:00 to 08:45 - Peak 1 of 1																	
Intersection 07:30																	
Volume	19	404	183	606	99	71	370	540	496	289	25	810	43	153	22	218	2174
Percent	3.1	66.7	30.2		18.3	13.1	68.5		61.2	35.7	3.1		19.7	70.2	10.1		
08:15 Volume	6	100	30	136	25	32	144	201	139	67	14	220	15	66	10	91	648
Peak Factor																	0.839
High Int. 07:30																	
Volume	4	115	56	175	25	32	144	201	139	67	14	220	15	66	10	91	
Peak Factor				0.866				0.672				0.920					0.599

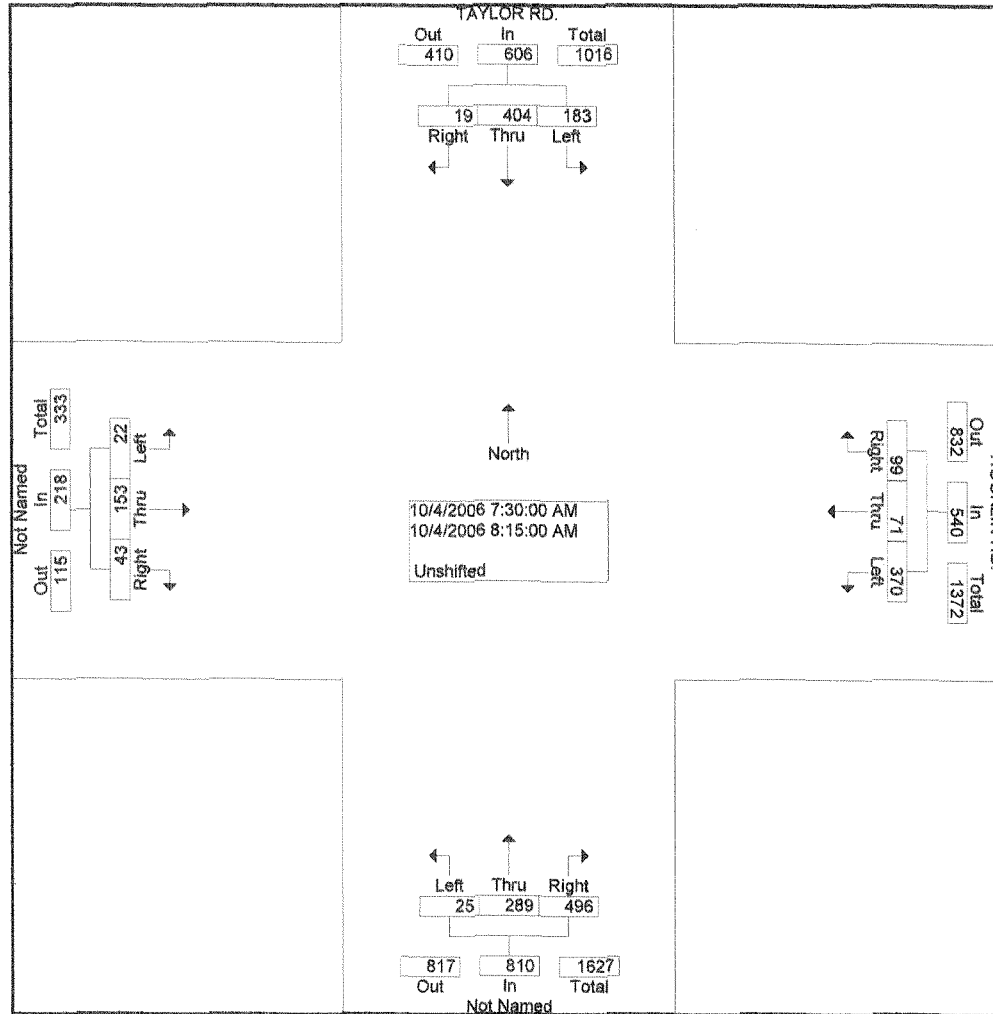

ALL TRAFFIC DATA INC.

(916)771-8700

FAX 786-2879

File Name : F-Taylor-Rocklin Rd

Site Code : 00000000

Start Date : 10/4/2006

Page No : 3

Start Time	TAYLOR RD. Southbound				ROCKLIN RD. Westbound				Northbound				Eastbound				Int. Total
	Right	Thru	Left	App. Total	Right	Thru	Left	App. Total	Right	Thru	Left	App. Total	Right	Thru	Left	App. Total	
Peak Hour From 16:00 to 17:45 - Peak 1 of 1																	
Intersection	16:30																
Volume	21	514	122	657	221	148	595	964	509	443	41	993	23	113	34	170	2784
Percent	3.2	78.2	18.6		22.9	15.4	61.7		51.3	44.6	4.1		13.5	66.5	20.0		
17:00 Volume	10	113	22	145	76	30	164	270	127	130	11	268	3	44	10	57	740
Peak Factor	0.941																
High Int.	16:30																
Volume	5	136	40	181	76	30	164	270	127	130	11	268	3	44	10	57	
Peak Factor	0.907								0.893				0.926				0.746

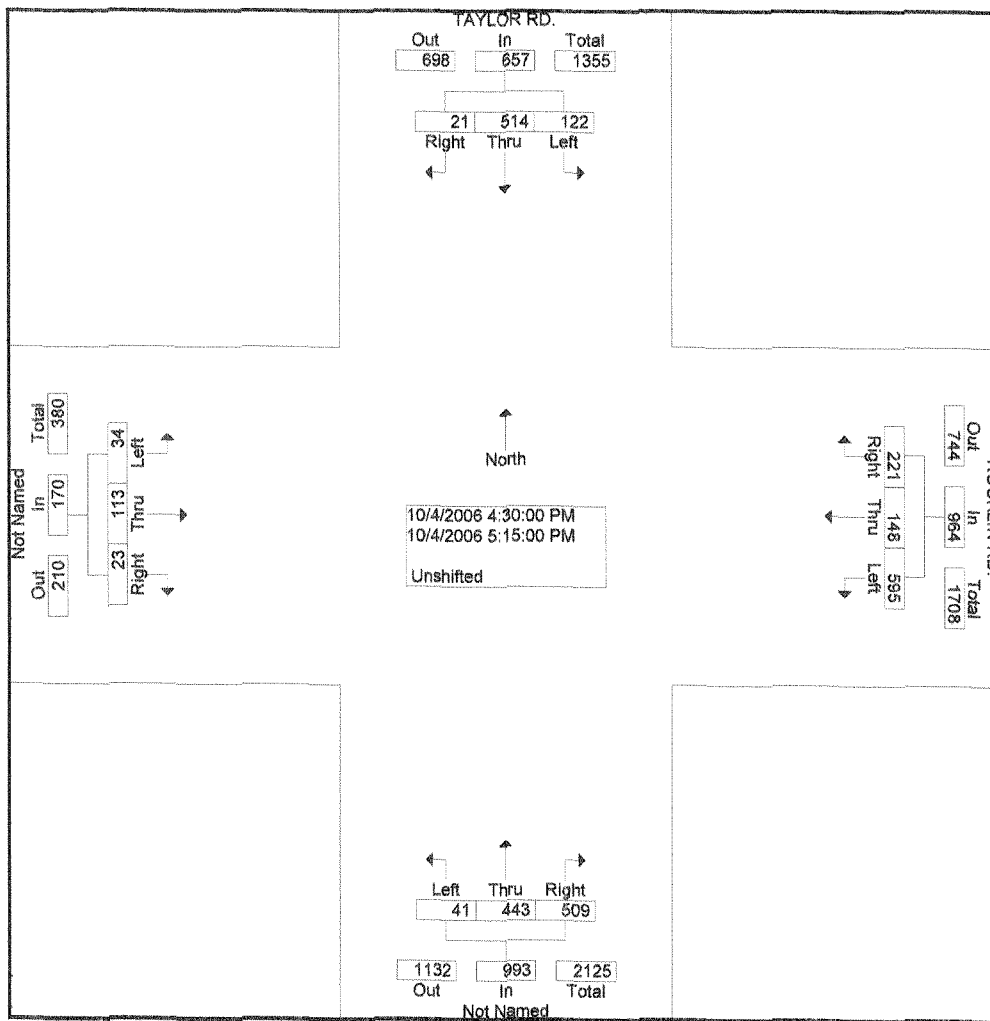

Intersection Turning Movement

Prepared by: Southland Car Counters

N-S STREET: Taylor Rd.

DATE: 08/19/2006

LOCATION: City of Rocklin

E-W STREET: Rocklin Rd.

DAY: SATURDAY

PROJECT# 06-7188-016

LANES:	NORTHBOUND			SOUTHBOUND			EASTBOUND			WESTBOUND			TOTAL
	NL	NT	NR	SL	ST	SR	EL	ET	ER	WL	WT	WR	
	1	2	1	1	2	0	1	1.5	.5	1.5	.5	1	
10:00 AM													
10:15 AM													
10:30 AM													
10:45 AM													
11:00 AM	4	45	85	19	60	3	5	11	4	65	9	16	326
11:15 AM	5	61	76	29	63	2	5	7	6	73	13	19	359
11:30 AM	6	53	91	19	74	4	3	9	4	80	16	22	381
11:45 AM	5	66	100	22	87	1	7	7	4	86	11	28	424
12:00 PM	3	71	105	25	67	2	10	14	8	78	10	17	410
12:15 PM	4	83	98	35	70	5	4	15	7	68	9	29	427
12:30 PM	3	56	94	28	80	8	1	20	3	72	18	40	423
12:45 PM	5	41	79	22	69	4	3	13	5	77	12	33	363
1:00 PM													
1:15 PM													
1:30 PM													
1:45 PM													
2:00 PM													
2:15 PM													
2:30 PM													
2:45 PM													

TOTAL VOLUMES =	NL	NT	NR	SL	ST	SR	EL	ET	ER	WL	WT	WR	TOTAL
	35	476	728	199	570	29	38	96	41	599	98	204	3113

NOON Peak Hr Begins at: 1145 AM

PEAK VOLUMES =	15	276	397	110	304	16	22	56	22	304	48	114	1684
PEAK HR. FACTOR:		0.930		0.927				0.781			0.896		0.986

CONTROL: Signalized

ALL TRAFFIC DATA INC.

(916)771-8700

FAX 786-2879

CITY OF ROCKLIN

File Name : F-Granite-Rocklin Rd.

Site Code : 00000000

Start Date : 10/4/2006

Page No : 1

Groups Printed- Unshifted

Start Time	GRANITE RD. Southbound				ROCKLIN RD. Westbound				Northbound				Eastbound				Int. Total
	Right	Thru	Left	App. Total	Right	Thru	Left	App. Total	Right	Thru	Left	App. Total	Right	Thru	Left	App. Total	
07:00	6	2	54	62	78	91	2	171	4	4	4	12	1	115	7	123	368
07:15	16	0	60	76	82	106	1	189	1	2	2	5	5	150	23	178	448
07:30	26	0	76	102	128	85	2	215	5	4	3	12	4	214	21	239	568
07:45	20	0	77	97	181	124	0	305	0	1	7	8	1	167	33	201	611
Total	68	2	267	337	469	406	5	880	10	11	16	37	11	646	84	741	1995
08:00	28	4	66	98	119	159	1	279	2	2	4	8	1	153	31	185	570
08:15	30	3	85	118	139	160	3	302	4	5	3	12	6	179	43	228	660
08:30	27	3	119	149	83	109	2	194	4	3	8	15	1	139	29	169	527
08:45	34	1	117	152	108	102	1	211	6	4	4	14	1	114	47	162	539
Total	119	11	387	517	449	530	7	986	16	14	19	49	9	585	150	744	2296
16:00	71	7	129	207	121	151	3	275	5	5	6	16	5	146	50	201	699
16:15	57	7	127	191	139	179	7	325	4	2	2	8	3	125	51	179	703
16:30	70	4	135	209	108	167	9	284	7	4	3	14	6	133	63	202	709
16:45	65	4	116	185	135	197	9	341	3	9	4	16	3	149	66	218	760
Total	263	22	507	792	503	694	28	1225	19	20	15	54	17	553	230	800	2871
17:00	101	2	123	226	115	196	15	326	9	2	8	19	6	183	65	254	825
17:15	89	2	119	210	162	218	13	393	9	5	6	20	9	175	57	241	864
17:30	85	5	126	216	138	161	8	307	6	3	5	14	5	155	53	213	750
17:45	82	7	121	210	171	170	4	345	11	4	4	19	3	163	58	224	798
Total	357	16	489	862	586	745	40	1371	35	14	23	72	23	676	233	932	3237
Grand Total	807	51	1650	2508	2007	2375	80	4462	80	59	73	212	60	2460	697	3217	10399
Apprch %	32.2	2.0	65.8		45.0	53.2	1.8		37.7	27.8	34.4		1.9	76.5	21.7		
Total %	7.8	0.5	15.9	24.1	19.3	22.8	0.8	42.9	0.8	0.6	0.7	2.0	0.6	23.7	6.7	30.9	

Start Time	GRANITE RD. Southbound				ROCKLIN RD. Westbound				Northbound				Eastbound				Int. Total
	Right	Thru	Left	App. Total	Right	Thru	Left	App. Total	Right	Thru	Left	App. Total	Right	Thru	Left	App. Total	
Peak Hour From 07:00 to 08:45 - Peak 1 of 1																	
Intersection	07:30																
Volume	104	7	304	415	567	528	6	1101	11	12	17	40	12	713	128	853	2409
Percent	25.1	1.7	73.3		51.5	48.0	0.5		27.5	30.0	42.5		1.4	83.6	15.0		
08:15 Volume	30	3	85	118	139	160	3	302	4	5	3	12	6	179	43	228	660
Peak Factor																	0.913
High Int.	08:15				07:45				07:30				07:30				
Volume	30	3	85	118	181	124	0	305	5	4	3	12	4	214	21	239	
Peak Factor					0.879				0.902				0.833				0.892

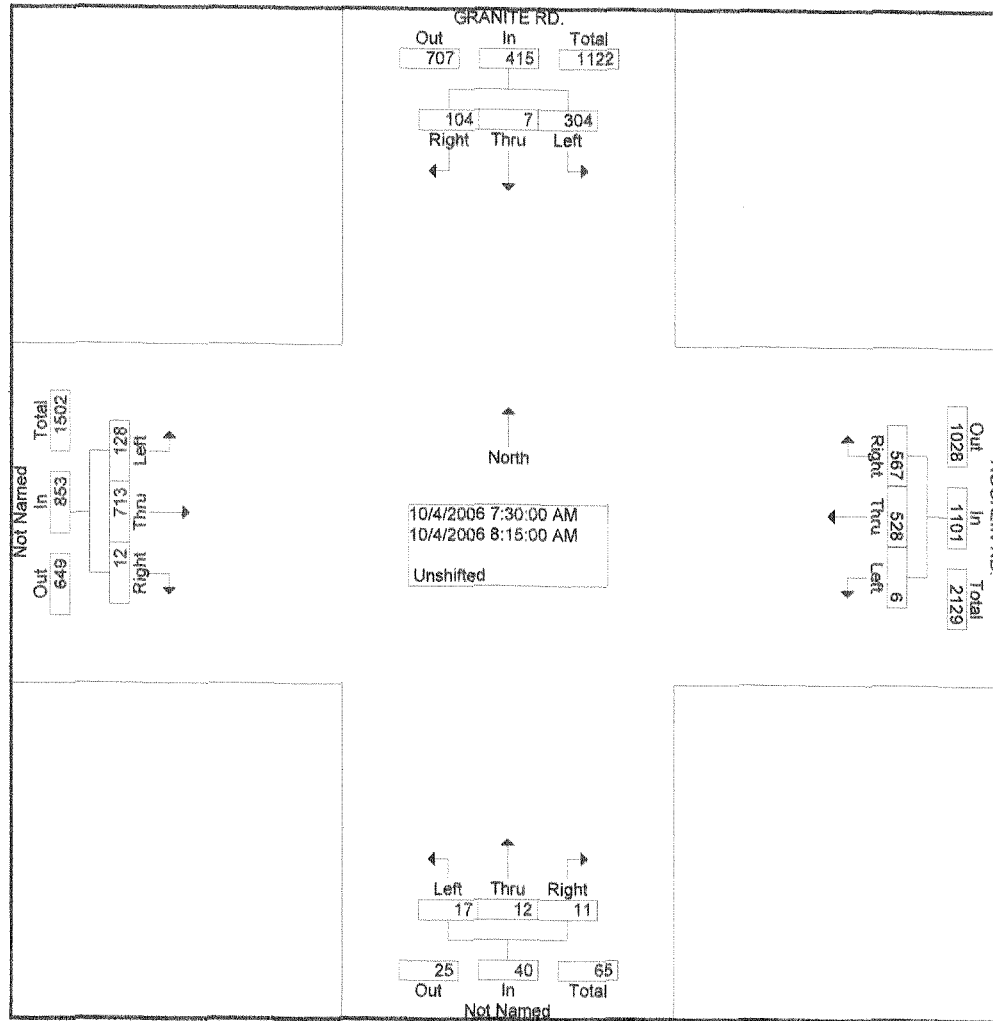

ALL TRAFFIC DATA INC.
(916)771-8700
FAX 786-2879

File Name : F-Granite-Rocklin Rd.
 Site Code : 00000000
 Start Date : 10/4/2006
 Page No : 3

Start Time	GRANITE RD. Southbound				ROCKLIN RD. Westbound				Northbound				Eastbound				Int. Total
	Right	Thru	Left	App. Total	Right	Thru	Left	App. Total	Right	Thru	Left	App. Total	Right	Thru	Left	App. Total	
Peak Hour From 16:00 to 17:45 - Peak 1 of 1																	
Intersection	17:00																
Volume	357	16	489	862	586	745	40	1371	35	14	23	72	23	676	233	932	3237
Percent	41.4	1.9	56.7		42.7	54.3	2.9		48.6	19.4	31.9		2.5	72.5	25.0		
17:15 Volume	89	2	119	210	162	218	13	393	9	5	6	20	9	175	57	241	864
Peak Factor																	0.937
High Int.	17:00																
Volume	101	2	123	226	162	218	13	393	9	5	6	20	6	183	65	254	
Peak Factor				0.954				0.872				0.900				0.917	

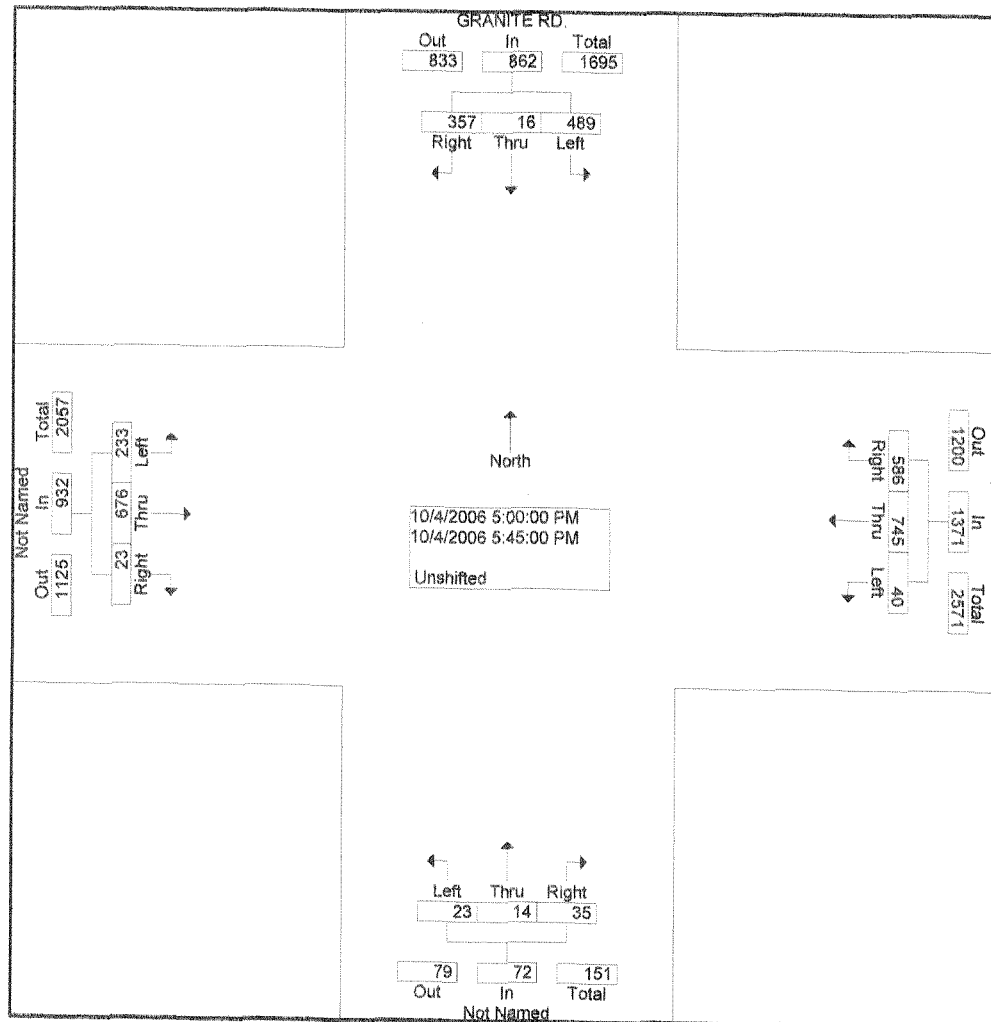

Intersection Turning Movement

Prepared by: Southland Car Counters

N-S STREET: Granite Dr.

DATE: 08/19/2006

LOCATION: City of Rocklin

E-W STREET: Rocklin Rd.

DAY: SATURDAY

PROJECT# 06-7188-017

LANES:	NORTHBOUND			SOUTHBOUND			EASTBOUND			WESTBOUND			TOTAL
	NL	NT	NR	SL	ST	SR	EL	ET	ER	WL	WT	WR	
	1	.5	.5	1.5	.5	1	1	2	0	1	2	1	
10:00 AM													
10:15 AM													
10:30 AM													
10:45 AM													
11:00 AM	10	2	5	85	0	30	50	52	3	1	66	81	385
11:15 AM	7	1	4	92	2	25	44	69	4	3	76	89	416
11:30 AM	9	1	3	113	4	32	41	82	5	5	88	103	486
11:45 AM	6	4	7	100	4	31	49	92	4	7	94	77	475
12:00 PM	4	7	10	106	5	41	42	100	2	12	92	65	486
12:15 PM	8	3	6	117	4	29	55	95	3	8	99	73	500
12:30 PM	14	2	6	125	9	28	66	91	2	8	95	80	526
12:45 PM	12	1	4	96	6	35	73	84	5	9	72	69	466
1:00 PM													
1:15 PM													
1:30 PM													
1:45 PM													
2:00 PM													
2:15 PM													
2:30 PM													
2:45 PM													

TOTAL VOLUMES =	NL	NT	NR	SL	ST	SR	EL	ET	ER	WL	WT	WR	TOTAL
	70	21	45	834	34	251	420	665	28	53	682	637	3740

NOON Peak Hr Begins at: 1145 AM

PEAK VOLUMES =	32	16	29	448	22	129	212	378	11	35	380	295	1987
PEAK HR. FACTOR:		0.875			0.924			0.945			0.970		0.944

CONTROL: Signalized

ALL TRAFFIC DATA INC.
(916)771-8700
FAX 786-2879

CITY OF ROCKLIN

File Name : F- 180 WB Ramps-Rocklin Rd. 3
 Site Code : 00000000
 Start Date : 10/4/2006
 Page No : 1

Groups Printed- Unshifted

Start Time	180 WB RAMPS Southbound				ROCKLIN RD. Westbound				Northbound				Eastbound				Int. Total
	Right	Thru	Left	App. Total	Right	Thru	Left	App. Total	Right	Thru	Left	App. Total	Right	Thru	Left	App. Total	
07:00	26	0	9	35	0	146	88	234	0	0	0	0	65	97	0	162	431
07:15	42	0	14	56	0	149	91	240	0	0	0	0	67	142	0	209	505
07:30	45	0	52	97	0	175	90	265	0	0	0	0	93	201	0	294	656
07:45	83	1	72	156	0	217	84	301	0	0	0	0	101	160	0	261	718
Total	196	1	147	344	0	687	353	1040	0	0	0	0	326	600	0	926	2310
08:00	63	1	22	86	0	219	87	306	0	0	0	0	82	122	0	204	596
08:15	53	0	11	64	0	251	78	329	0	0	0	0	136	121	0	257	650
08:30	40	0	11	51	0	163	77	240	0	0	0	0	154	134	0	288	579
08:45	37	1	12	50	0	176	93	269	0	0	0	0	112	124	0	236	555
Total	193	2	56	251	0	809	335	1144	0	0	0	0	484	501	0	985	2380
16:00	45	0	15	60	0	238	119	357	0	0	0	0	122	159	0	281	698
16:15	75	2	10	87	0	242	117	359	0	0	0	0	109	149	0	258	704
16:30	54	0	10	64	0	249	140	389	0	0	0	0	120	149	0	269	722
16:45	62	2	15	79	0	274	130	404	0	0	0	0	86	190	0	276	759
Total	236	4	50	290	0	1003	506	1509	0	0	0	0	437	647	0	1084	2883
17:00	57	0	13	70	0	278	137	415	0	0	0	0	180	178	0	358	843
17:15	76	0	8	84	0	291	122	413	0	0	0	0	131	165	0	296	793
17:30	63	0	16	79	0	259	114	373	0	0	0	0	119	168	0	287	739
17:45	50	0	10	60	0	296	97	393	0	0	0	0	100	153	0	253	706
Total	246	0	47	293	0	1124	470	1594	0	0	0	0	530	664	0	1194	3081
Grand Total	871	7	300	1178	0	3623	1664	5287	0	0	0	0	1777	2412	0	4189	10654
Apprch %	73.9	0.6	25.5		0.0	68.5	31.5		0.0	0.0	0.0		42.4	57.6	0.0		
Total %	8.2	0.1	2.8	11.1	0.0	34.0	15.6	49.6	0.0	0.0	0.0	0.0	16.7	22.6	0.0	39.3	

Start Time	180 WB RAMPS Southbound				ROCKLIN RD. Westbound				Northbound				Eastbound				Int. Total
	Right	Thru	Left	App. Total	Right	Thru	Left	App. Total	Right	Thru	Left	App. Total	Right	Thru	Left	App. Total	
Peak Hour From 07:00 to 08:45 - Peak 1 of 1																	
Intersection	07:30																
Volume	244	2	157	403	0	862	339	1201	0	0	0	0	412	604	0	1016	2620
Percent	60.5	0.5	39.0		0.0	71.8	28.2		0.0	0.0	0.0		40.6	59.4	0.0		
07:45 Volume	83	1	72	156	0	217	84	301	0	0	0	0	101	160	0	261	718
Peak Factor																	0.912
High Int.	07:45				08:15				6:45:00 AM				07:30				
Volume	83	1	72	156	0	251	78	329	0	0	0	0	93	201	0	294	
Peak Factor				0.646				0.913								0.864	

ALL TRAFFIC DATA INC.

(916)771-8700

FAX 786-2879

File Name : F- 180 WB Ramps-Rocklin Rd.

Site Code : 00000000

Start Date : 10/4/2006

Page No : 2

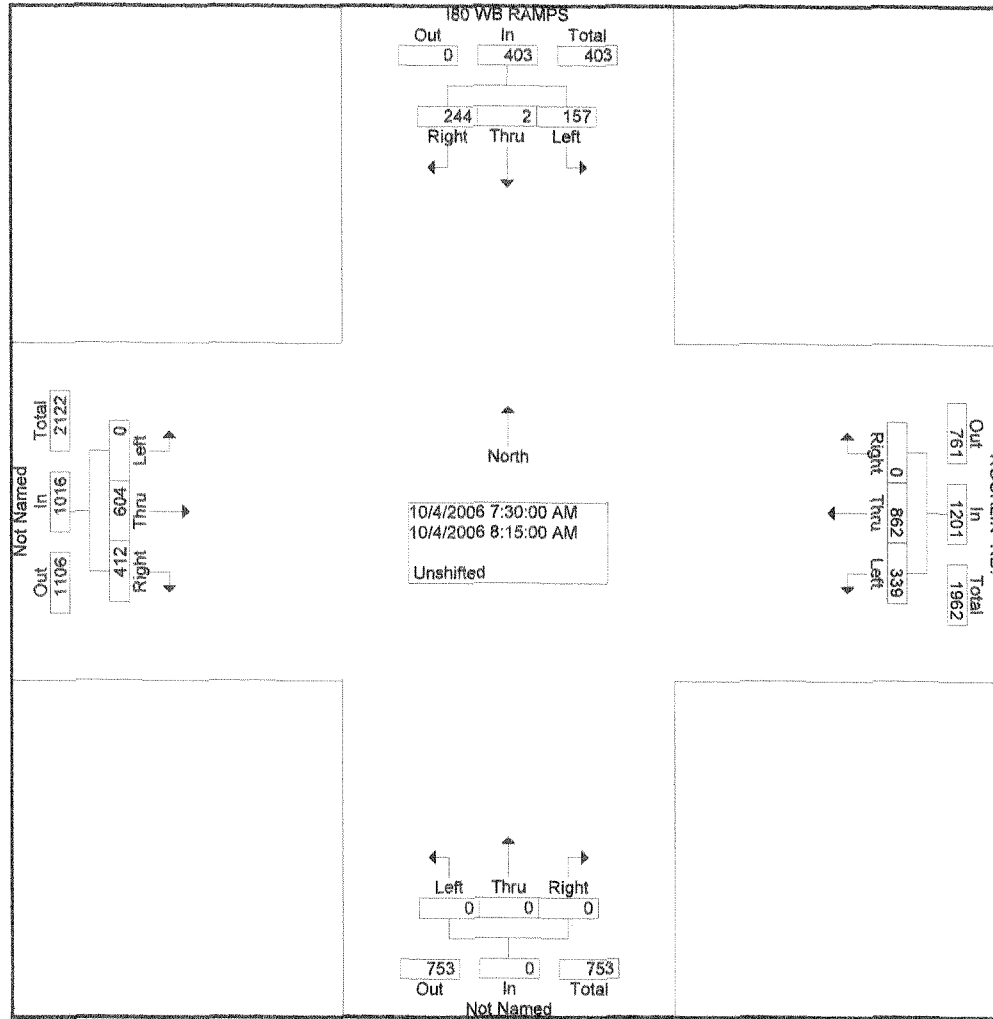

ALL TRAFFIC DATA INC.
(916)771-8700
FAX 786-2879

File Name : F- 180 WB Ramps-Rocklin Rd.
 Site Code : 00000000
 Start Date : 10/4/2006
 Page No : 3

Start Time	180 WB RAMPS Southbound				ROCKLIN RD. Westbound				Northbound				Eastbound				Int. Total
	Right	Thru	Left	App. Total	Right	Thru	Left	App. Total	Right	Thru	Left	App. Total	Right	Thru	Left	App. Total	
Peak Hour From 16:00 to 17:45 - Peak 1 of 1																	
Intersection	16:45																
Volume	258	2	52	312	0	1102	503	1605	0	0	0	0	516	701	0	1217	3134
Percent	82.7	0.6	16.7		0.0	68.7	31.3		0.0	0.0	0.0		42.4	57.6	0.0		
17:00 Volume	57	0	13	70	0	278	137	415	0	0	0	0	180	178	0	358	843
Peak Factor																	0.929
High Int.	17:15					17:00							17:00				
Volume	76	0	8	84	0	278	137	415	0	0	0	0	180	178	0	358	
Peak Factor				0.929				0.967								0.850	

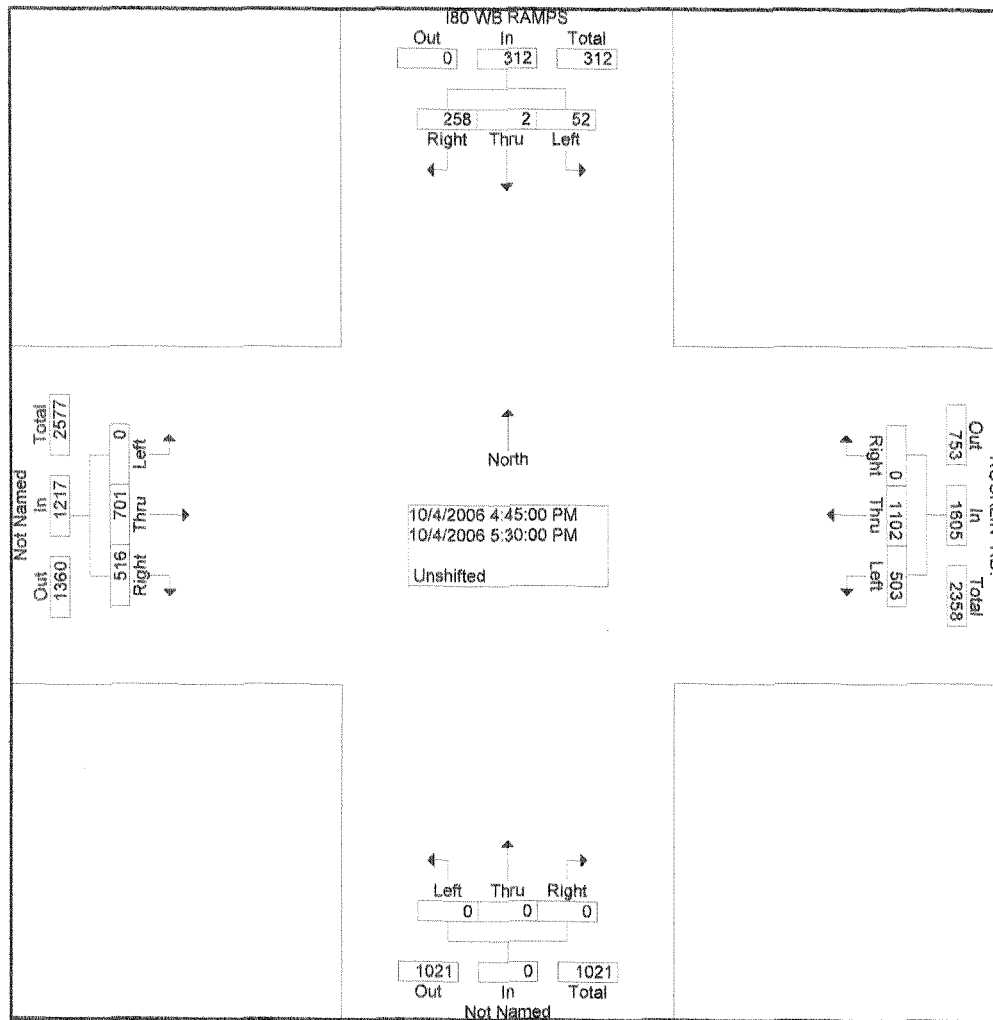

Intersection Turning Movement

Prepared by: Southland Car Counters

N-S STREET: I-80 SB Ramps DATE: 08/19/2006 LOCATION: City of Rocklin
 E-W STREET: Rocklin Rd. DAY: SATURDAY PROJECT# 06-7188-007

LANES:	NORTHBOUND			SOUTHBOUND			EASTBOUND			WESTBOUND			TOTAL
	NL	NT	NR	SL	ST	SR	EL	ET	ER	WL	WT	WR	
	0	0	0	1.3	.3	.3	0	2	0	1	2	0	
10:00 AM													
10:15 AM													
10:30 AM													
10:45 AM													
11:00 AM				109	1	69		137	20	30	65		431
11:15 AM				88	1	74		159	14	31	82		449
11:30 AM				73	0	83		166	18	35	91		466
11:45 AM				62	0	95		183	16	43	110		509
12:00 PM				78	0	105		144	24	36	96		483
12:15 PM				84	1	87		116	13	26	76		403
12:30 PM				71	0	72		93	20	29	62		347
12:45 PM				75	1	65		79	17	17	67		321
1:00 PM													
1:15 PM													
1:30 PM													
1:45 PM													
2:00 PM													
2:15 PM													
2:30 PM													
2:45 PM													

TOTAL VOLUMES =	NL	NT	NR	SL	ST	SR	EL	ET	ER	WL	WT	WR	TOTAL
	0	0	0	640	4	650	0	1077	142	247	649	0	3409

NOON Peak Hr Begins at: 1115 AM

PEAK VOLUMES =	0	0	0	301	1	357	0	652	72	145	379	0	1907
PEAK HR. FACTOR:		0.000			0.900			0.000			0.856		0.937

CONTROL: Signalized

ALL TRAFFIC DATA INC.

(916)771-8700

FAX 786-2879

CITY OF ROCKLIN

File Name : F-Rocklin Rd.-180 EB
 Site Code : 00000000
 Start Date : 11/4/2006
 Page No : 1

4

Groups Printed- Unshifted

Start Time	Southbound				ROCKLIN RD. Westbound				180 EB RAMPS Northbound				Eastbound				Int. Total
	Right	Thru	Left	App. Total	Right	Thru	Left	App. Total	Right	Thru	Left	App. Total	Right	Thru	Left	App. Total	
07:00	0	0	0	0	7	147	0	154	96	0	85	181	0	70	45	115	450
07:15	0	0	0	0	7	144	0	151	167	1	105	273	0	101	47	148	572
07:30	0	0	0	0	10	146	0	156	263	1	115	379	0	176	79	255	790
07:45	0	0	0	0	15	125	0	140	226	1	165	392	0	182	45	227	759
Total	0	0	0	0	39	562	0	601	752	3	470	1225	0	529	216	745	2571
08:00	0	0	0	0	11	175	0	186	131	0	135	266	0	108	47	155	607
08:15	0	0	0	0	11	169	0	180	115	0	155	270	0	103	37	140	590
08:30	0	0	0	0	11	122	6	139	105	1	109	215	0	106	47	153	507
08:45	0	0	0	0	7	130	0	137	141	1	122	264	0	113	33	146	547
Total	0	0	0	0	40	596	6	642	492	2	521	1015	0	430	164	594	2251
16:00	0	0	0	0	33	218	0	251	114	0	142	256	0	122	53	175	682
16:15	0	0	0	0	25	222	0	247	111	1	139	251	0	121	46	167	665
16:30	0	0	0	0	34	264	0	298	146	1	124	271	0	118	42	160	729
16:45	0	0	0	0	31	252	0	283	137	0	145	282	0	138	55	193	758
Total	0	0	0	0	123	956	0	1079	508	2	550	1060	0	499	196	695	2834
17:00	0	0	0	0	31	296	0	327	147	1	127	275	0	133	52	185	787
17:15	0	0	0	0	31	259	0	290	162	0	147	309	0	125	51	176	775
17:30	0	0	0	0	26	260	0	286	156	0	129	285	0	131	53	184	755
17:45	0	0	0	0	13	228	0	241	154	0	145	299	0	131	39	170	710
Total	0	0	0	0	101	1043	0	1144	619	1	548	1168	0	520	195	715	3027
Grand Total	0	0	0	0	303	3157	6	3466	2371	8	2089	4468	0	1978	771	2749	10683
Apprch %	0.0	0.0	0.0		8.7	91.1	0.2		53.1	0.2	46.8		0.0	72.0	28.0		
Total %	0.0	0.0	0.0	0.0	2.8	29.6	0.1	32.4	22.2	0.1	19.6	41.8	0.0	18.5	7.2	25.7	

Start Time	Southbound				ROCKLIN RD. Westbound				180 EB RAMPS Northbound				Eastbound				Int. Total
	Right	Thru	Left	App. Total	Right	Thru	Left	App. Total	Right	Thru	Left	App. Total	Right	Thru	Left	App. Total	
Peak Hour From 07:00 to 08:45 - Peak 1 of 1																	
Intersection	07:30																
Volume	0	0	0	0	47	615	0	662	735	2	570	1307	0	569	208	777	2746
Percent	0.0	0.0	0.0		7.1	92.9	0.0		56.2	0.2	43.6		0.0	73.2	26.8		790
07:30 Volume	0	0	0	0	10	146	0	156	263	1	115	379	0	176	79	255	869
Peak Factor																	
High Int.	6:45:00 AM				08:00				07:45				07:30				
Volume	0	0	0	0	11	175	0	186	226	1	165	392	0	176	79	255	
Peak Factor					0.890				0.834				0.762				

ALL TRAFFIC DATA INC.

(916)771-8700

FAX 786-2879

File Name : F-Rocklin Rd.-I80 EB

Site Code : 00000000

Start Date : 11/4/2006

Page No : 2

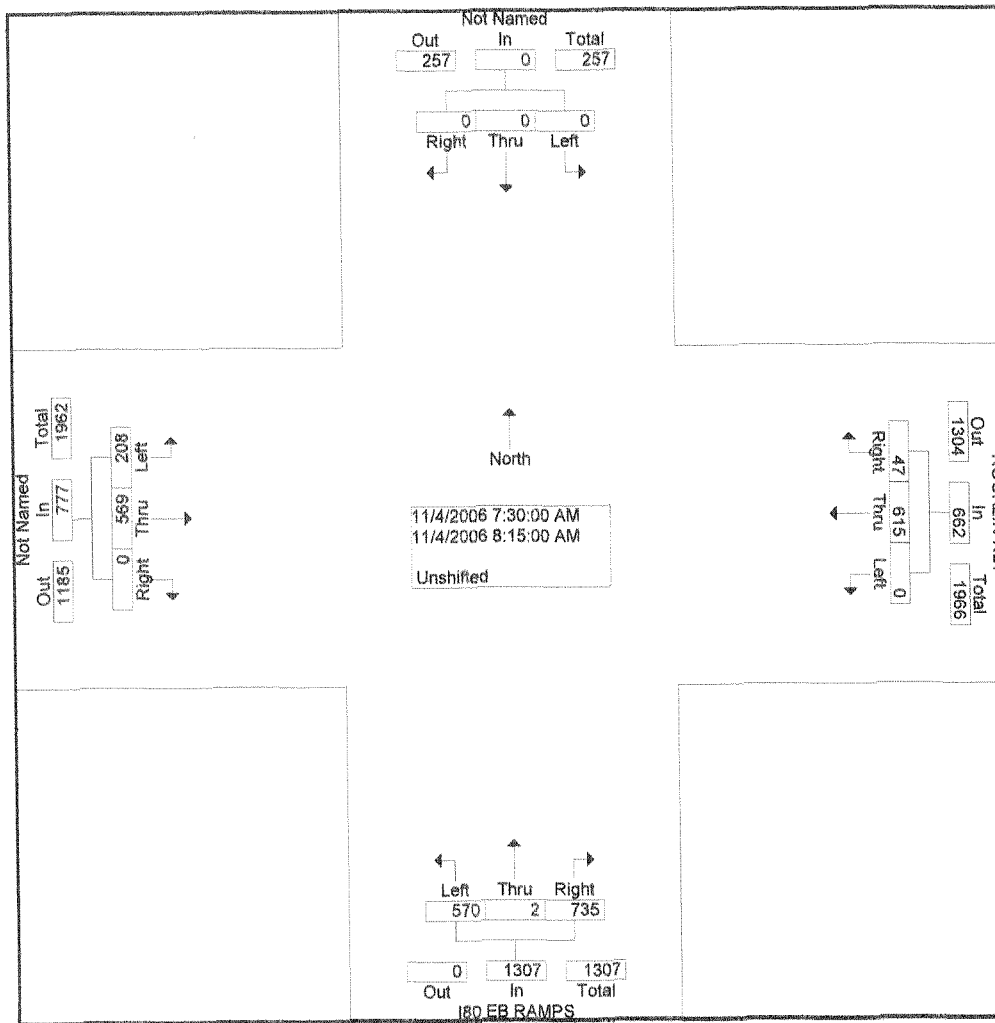

ALL TRAFFIC DATA INC.
(916)771-8700
FAX 786-2879

File Name : F-Rocklin Rd.-I80 EB
 Site Code : 00000000
 Start Date : 11/4/2006
 Page No : 3

Start Time	Southbound				ROCKLIN RD. Westbound				I80 EB RAMPS Northbound				Eastbound				Int. Total
	Right	Thru	Left	App. Total	Right	Thru	Left	App. Total	Right	Thru	Left	App. Total	Right	Thru	Left	App. Total	
Peak Hour From 16:00 to 17:45 - Peak 1 of 1																	
Intersection 16:45																	
Volume	0	0	0	0	119	1067	0	1186	602	1	548	1151	0	527	211	738	3075
Percent	0.0	0.0	0.0	0.0	10.0	90.0	0.0	1186	52.3	0.1	47.6	1151	0.0	71.4	28.6	738	3075
17:00 Volume	0	0	0	0	31	296	0	327	147	1	127	275	0	133	52	185	787
Peak Factor																	0.977
High Int.					17:00				17:15				16:45				
Volume	0	0	0	0	31	296	0	327	162	0	147	309	0	138	55	193	
Peak Factor								0.907				0.931				0.956	

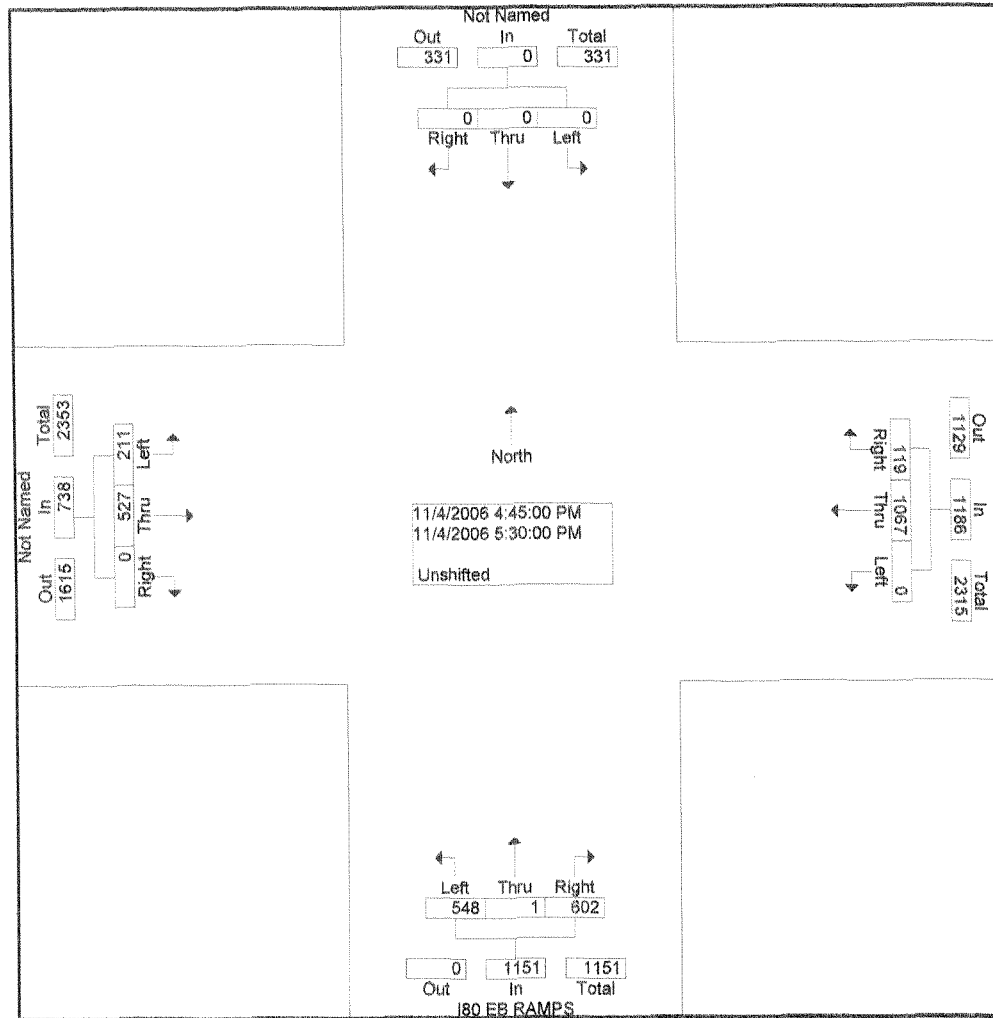

Intersection Turning Movement

Prepared by: Southland Car Counters

N-S STREET: I-80 NB Ramps

DATE: 08/19/2006

LOCATION: City of Rocklin

E-W STREET: Rocklin Rd.

DAY: SATURDAY

PROJECT# 06-7188-008

LANES:	NORTHBOUND			SOUTHBOUND			EASTBOUND			WESTBOUND			TOTAL
	NL	NT	NR	SL	ST	SR	EL	ET	ER	WL	WT	WR	
	1	.5	.5	0	0	0	1	2	0	0	2	1	
10:00 AM													
10:15 AM													
10:30 AM													
10:45 AM													
11:00 AM	4		46				42	129			82	96	399
11:15 AM	4		35				36	169			119	62	425
11:30 AM	4		27				37	184			121	68	441
11:45 AM	7		37				44	209			135	74	506
12:00 PM	6		21				58	195			112	61	453
12:15 PM	9		29				64	169			98	58	427
12:30 PM	5		35				51	149			99	69	408
12:45 PM	4		27				40	141			97	51	360
1:00 PM													
1:15 PM													
1:30 PM													
1:45 PM													
2:00 PM													
2:15 PM													
2:30 PM													
2:45 PM													

TOTAL VOLUMES =	NL	NT	NR	SL	ST	SR	EL	ET	ER	WL	WT	WR	TOTAL
	43	0	257	0	0	0	372	1345	0	0	863	539	3419

NOON Peak Hr Begins at: 1130 AM

PEAK VOLUMES =	26	0	114	0	0	0	203	757	0	0	466	261	1827
PEAK HR. FACTOR:		0.795			0.000			0.949			0.000		0.903

CONTROL: Signalized

ALL TRAFFIC DATA INC.
(916)771-8700
FAX 786-2879

CITY OF ROCKLIN

File Name : F-Pacific-Dominguez
 Site Code : 00000000
 Start Date : 10/4/2006
 Page No : 1

5

Groups Printed- Unshifted

Start Time	DEL MAR AVE. Southbound				PACIFIC ST. Westbound				DOMINGUEZ RD. Northbound				Eastbound				Int. Total
	Right	Thru	Left	App. Total	Right	Thru	Left	App. Total	Right	Thru	Left	App. Total	Right	Thru	Left	App. Total	
07:00	14	7	3	24	11	63	7	81	9	16	5	30	9	53	12	74	209
07:15	12	4	9	25	14	64	9	87	2	18	6	26	10	76	6	92	230
07:30	13	3	4	20	9	67	14	90	10	22	8	40	12	93	18	123	273
07:45	14	6	7	27	25	70	18	113	22	16	1	39	5	81	30	116	295
Total	53	20	23	96	59	264	48	371	43	72	20	135	36	303	66	405	1007
08:00	12	4	7	23	12	68	23	103	12	17	9	38	10	73	12	95	259
08:15	11	3	5	19	15	87	11	113	15	13	5	33	9	71	11	91	256
08:30	14	8	9	31	12	84	5	101	11	14	2	27	8	72	13	93	252
08:45	9	7	10	26	13	75	7	95	13	9	6	28	7	82	17	106	255
Total	46	22	31	99	52	314	46	412	51	53	22	126	34	298	53	385	1022
16:00	25	6	11	42	6	92	7	105	14	2	5	21	7	103	9	119	287
16:15	21	7	5	33	7	116	8	131	14	5	9	28	5	107	8	120	312
16:30	31	12	10	53	3	130	8	141	13	1	7	21	6	101	3	110	325
16:45	24	10	10	44	5	109	8	122	12	8	7	27	4	102	6	112	305
Total	101	35	36	172	21	447	31	499	53	16	28	97	22	413	26	461	1229
17:00	53	17	13	83	3	105	4	112	7	5	2	14	5	91	10	106	315
17:15	24	11	6	41	1	101	6	108	11	2	10	23	11	97	11	119	291
17:30	25	4	4	33	2	88	4	94	4	1	5	10	7	95	10	112	249
17:45	15	9	2	26	1	74	3	78	5	5	3	13	8	93	10	111	228
Total	117	41	25	183	7	368	17	392	27	13	20	60	31	376	41	448	1083
Grand Total	317	118	115	550	139	1393	142	1674	174	154	90	418	123	1390	186	1699	4341
Apprch %	57.6	21.5	20.9		8.3	83.2	8.5		41.6	36.8	21.5		7.2	81.8	10.9		
Total %	7.3	2.7	2.6	12.7	3.2	32.1	3.3	38.6	4.0	3.5	2.1	9.6	2.8	32.0	4.3	39.1	

Start Time	DEL MAR AVE. Southbound				PACIFIC ST. Westbound				DOMINGUEZ RD. Northbound				Eastbound				Int. Total
	Right	Thru	Left	App. Total	Right	Thru	Left	App. Total	Right	Thru	Left	App. Total	Right	Thru	Left	App. Total	
Peak Hour From 07:00 to 08:45 - Peak 1 of 1																	
Intersection 07:30																	
Volume	50	16	23	89	61	292	66	419	59	68	23	150	36	318	71	425	1083
Percent	56.2	18.0	25.8		14.6	69.7	15.8		39.3	45.3	15.3		8.5	74.8	16.7		
07:45 Volume	14	6	7	27	25	70	18	113	22	16	1	39	5	81	30	116	295
Peak Factor																	
High Int. 07:45																	
Volume	14	6	7	27	25	70	18	113	10	22	8	40	12	93	18	123	0.918
Peak Factor	0.824				0.927				0.938				0.864				

ALL TRAFFIC DATA INC.

(916)771-8700

FAX 786-2879

File Name : F-Pacific-Dominguez

Site Code : 00000000

Start Date : 10/4/2006

Page No : 2

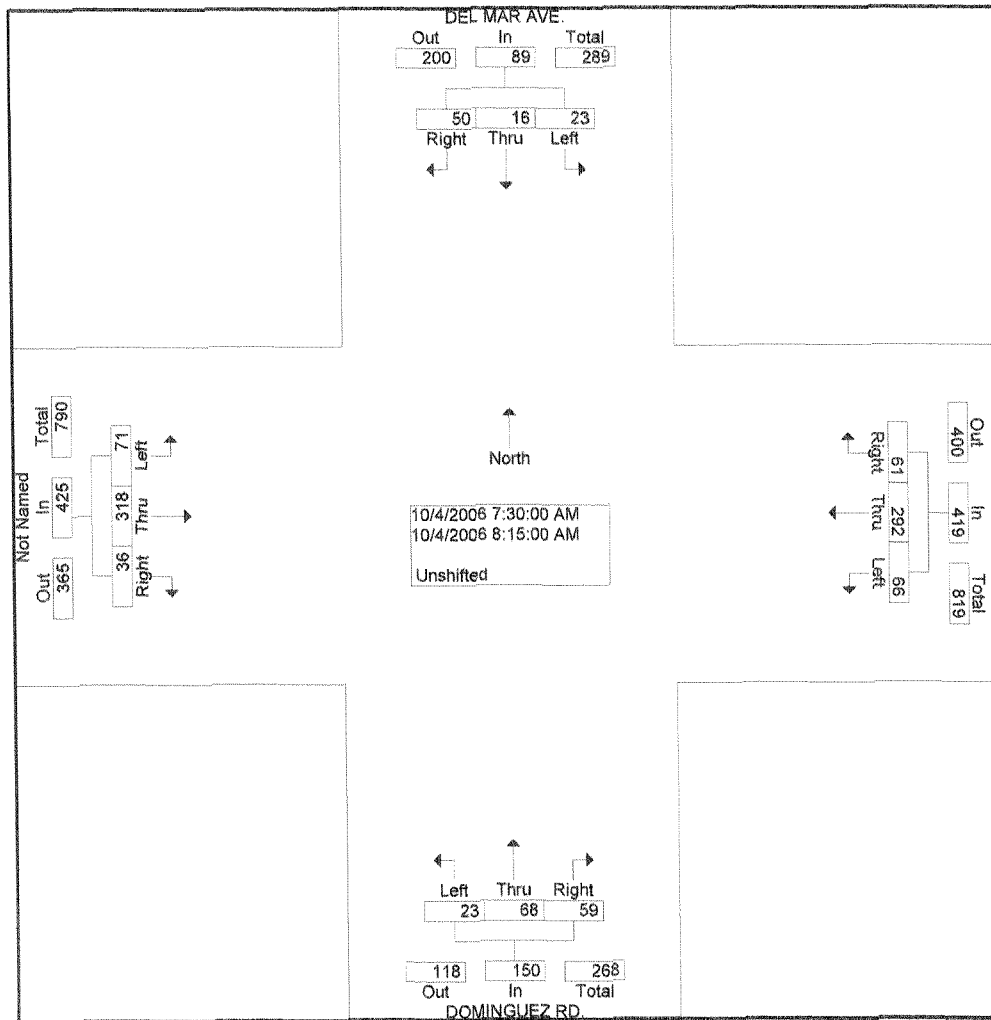

ALL TRAFFIC DATA INC.

(916)771-8700

FAX 786-2879

File Name : F-Pacific-Dominguez

Site Code : 00000000

Start Date : 10/4/2006

Page No : 3

Start Time	DEL MAR AVE. Southbound				PACIFIC ST. Westbound				DOMINGUEZ RD. Northbound				Eastbound				Int. Total	
	Right	Thru	Left	App. Total	Right	Thru	Left	App. Total	Right	Thru	Left	App. Total	Right	Thru	Left	App. Total		
Peak Hour From 16:00 to 17:45 - Peak 1 of 1																		
Intersection 16:15																		
Volume	129	46	38	213	18	460	28	506	46	19	25	90	20	401	27	448	1257	
Percent	60.6	21.6	17.8		3.6	90.9	5.5		51.1	21.1	27.8		4.5	89.5	6.0			
16:30 Volume	31	12	10	53	3	130	8	141	13	1	7	21	6	101	3	110	325	
Peak Factor																		
High Int. 17:00																		
Volume	53	17	13	83	16:30	3	130	8	141	16:15	14	5	9	16:15	5	107	8	120
Peak Factor	0.642				0.897				0.804				0.933					

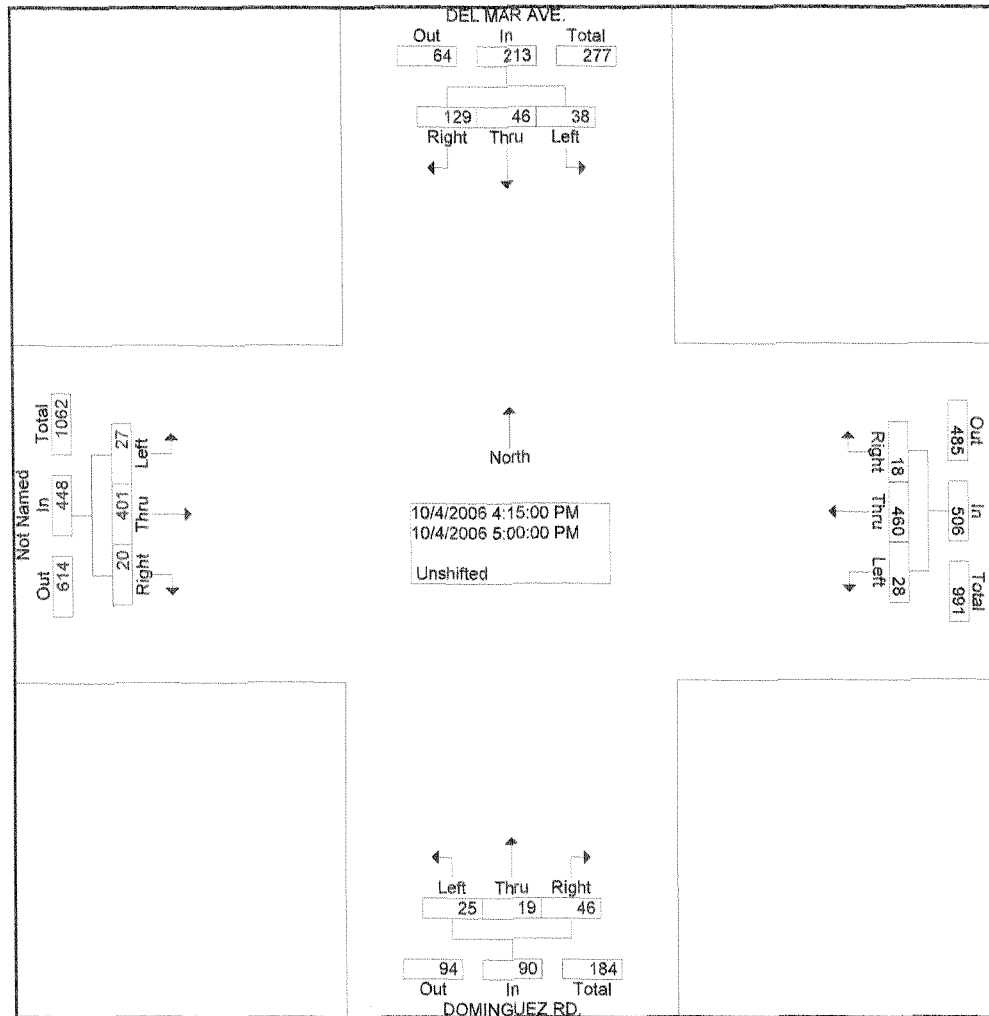

Intersection Turning Movement

Prepared by: Southland Car Counters

N-S STREET: Dominguez Rd

DATE: 08/26/2006

LOCATION: City of Rocklin

E-W STREET: Pacific St

DAY: SATURDAY

PROJECT# 06-7188-010

LANES:	NORTHBOUND			SOUTHBOUND			EASTBOUND			WESTBOUND			TOTAL
	NL	NT	NR	SL	ST	SR	EL	ET	ER	WL	WT	WR	
	1	1	0	1	1	0	0	0	1	0	1	1	

10:00 AM													
10:15 AM													
10:30 AM													
10:45 AM													
11:00 AM	0	0	0	0	1	4	4	43	0	1	44	0	97
11:15 AM	2	1	2	2	2	2	2	55	2	4	53	1	128
11:30 AM	6	2	1	0	0	1	1	44	4	3	39	0	101
11:45 AM	1	1	1	2	3	4	3	67	3	2	58	1	146
12:00 PM	2	3	1	2	1	7	2	82	3	6	49	1	159
12:15 PM	2	4	2	1	2	3	3	74	1	2	74	3	171
12:30 PM	0	1	3	0	4	6	5	63	1	5	64	0	152
12:45 PM	1	1	3	1	2	4	6	56	2	4	51	2	133
1:00 PM													
1:15 PM													
1:30 PM													
1:45 PM													
2:00 PM													
2:15 PM													
2:30 PM													
2:45 PM													

TOTAL VOLUMES =	NL	NT	NR	SL	ST	SR	EL	ET	ER	WL	WT	WR	TOTAL
	14	13	13	8	15	31	26	484	16	27	432	8	1087

NOON Peak Hr Begins at: 1145 AM

PEAK VOLUMES =	5	9	7	5	10	20	13	286	8	15	245	5	628
PEAK HR. FACTOR:	0.656			0.875			0.882			0.839			0.918

CONTROL: Signalized

ALL TRAFFIC DATA INC.

(916)771-8700

FAX 786-2879

CITY OF ROCKLIN

File Name : F-Granite-Dominguez

Site Code : 00000000

Start Date : 10/4/2006

Page No : 1

6

Groups Printed- Unshifted

Start Time	GRANITE RD. Southbound				DOMINGUEZ RD. Westbound				Northbound				Eastbound				Int. Total
	Right	Thru	Left	App. Total	Right	Thru	Left	App. Total	Right	Thru	Left	App. Total	Right	Thru	Left	App. Total	
07:00	10	15	0	25	0	0	0	0	0	14	21	35	11	0	15	26	86
07:15	17	29	0	46	0	0	0	0	0	8	19	27	5	0	12	17	90
07:30	20	39	0	59	0	0	0	0	0	21	20	41	10	0	13	23	123
07:45	14	73	0	87	0	0	0	0	0	20	27	47	14	0	12	26	160
Total	61	156	0	217	0	0	0	0	0	63	87	150	40	0	52	92	459
08:00	10	58	0	68	0	0	0	0	0	26	21	47	26	0	4	30	145
08:15	12	76	0	88	0	0	0	0	0	16	15	31	16	0	7	23	142
08:30	11	48	0	59	0	0	0	0	0	28	23	51	14	0	13	27	137
08:45	10	40	0	50	0	0	0	0	0	23	7	30	21	0	11	32	112
Total	43	222	0	265	0	0	0	0	0	93	66	159	77	0	35	112	536
16:00	5	50	0	55	0	0	0	0	0	76	6	82	17	0	15	32	169
16:15	5	57	0	62	0	0	0	0	0	50	13	63	10	0	12	22	147
16:30	8	49	0	57	0	0	0	0	0	72	9	81	9	0	13	22	160
16:45	6	48	0	54	0	0	0	0	0	73	8	81	16	0	11	27	162
Total	24	204	0	228	0	0	0	0	0	271	36	307	52	0	51	103	638
17:00	6	46	0	52	0	0	0	0	0	84	8	92	20	0	26	46	190
17:15	4	54	0	58	0	0	0	0	0	64	5	69	18	0	10	28	155
17:30	3	35	0	38	0	0	0	0	0	77	7	84	5	0	7	12	134
17:45	7	42	0	49	0	0	0	0	0	68	8	76	11	0	3	14	139
Total	20	177	0	197	0	0	0	0	0	293	28	321	54	0	46	100	618
Grand Total	148	759	0	907	0	0	0	0	0	720	217	937	223	0	184	407	2251
Apprch %	16.3	83.7	0.0		0.0	0.0	0.0		0.0	76.8	23.2		54.8	0.0	45.2		
Total %	6.6	33.7	0.0	40.3	0.0	0.0	0.0	0.0	0.0	32.0	9.6	41.6	9.9	0.0	8.2	18.1	

Start Time	GRANITE RD. Southbound				DOMINGUEZ RD. Westbound				Northbound				Eastbound				Int. Total
	Right	Thru	Left	App. Total	Right	Thru	Left	App. Total	Right	Thru	Left	App. Total	Right	Thru	Left	App. Total	
Peak Hour From 07:00 to 08:45 - Peak 1 of 1																	
Intersection	07:45																
Volume	47	255	0	302	0	0	0	0	0	90	86	176	70	0	36	106	584
Percent	15.6	84.4	0.0		0.0	0.0	0.0		0.0	51.1	48.9		66.0	0.0	34.0		
07:45 Volume	14	73	0	87	0	0	0	0	0	20	27	47	14	0	12	26	160
Peak Factor																	0.913
High Int.	08:15				6:45:00 AM					08:30			08:00				
Volume	12	76	0	88	0	0	0	0	0	28	23	51	26	0	4	30	
Peak Factor				0.858								0.863				0.883	

ALL TRAFFIC DATA INC.

(916)771-8700

FAX 786-2879

File Name : F-Granite-Dominguez

Site Code : 00000000

Start Date : 10/4/2006

Page No : 2

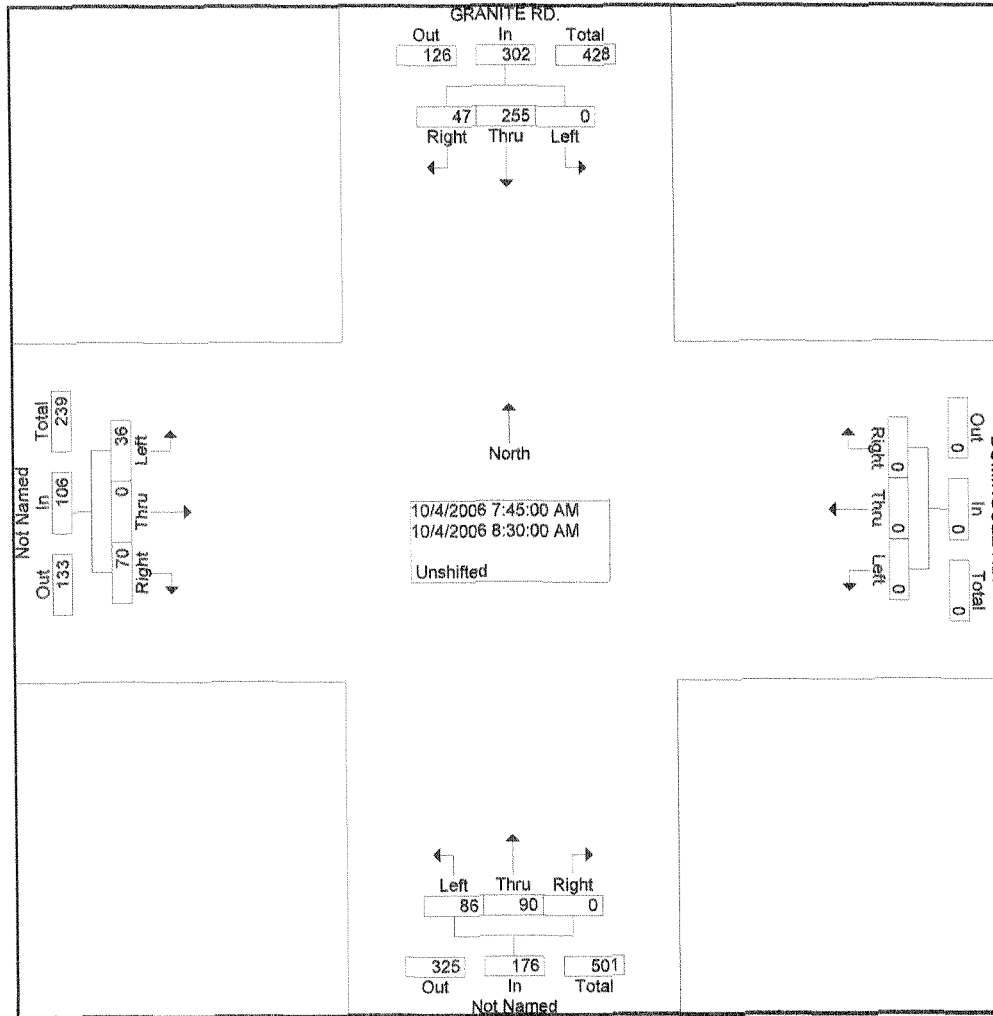

ALL TRAFFIC DATA INC.

(916)771-8700

FAX 786-2879

File Name : F-Granite-Dominguez

Site Code : 00000000

Start Date : 10/4/2006

Page No : 3

Start Time	GRANITE RD. Southbound				DOMINGUEZ RD. Westbound				Northbound				Eastbound				Int. Total
	Right	Thru	Left	App. Total	Right	Thru	Left	App. Total	Right	Thru	Left	App. Total	Right	Thru	Left	App. Total	
Peak Hour From 16:00 to 17:45 - Peak 1 of 1																	
Intersection	16:30																
Volume	24	197	0	221	0	0	0	0	0	293	30	323	63	0	60	123	667
Percent	10.9	89.1	0.0		0.0	0.0	0.0		0.0	90.7	9.3		51.2	0.0	48.8		
17:00 Volume	6	46	0	52	0	0	0	0	0	84	8	92	20	0	26	46	190
Peak Factor	0.878																
High Int.	17:15																
Volume	4	54	0	58	0	0	0	0	0	84	8	92	20	0	26	46	
Peak Factor	0.953																
																	0.668

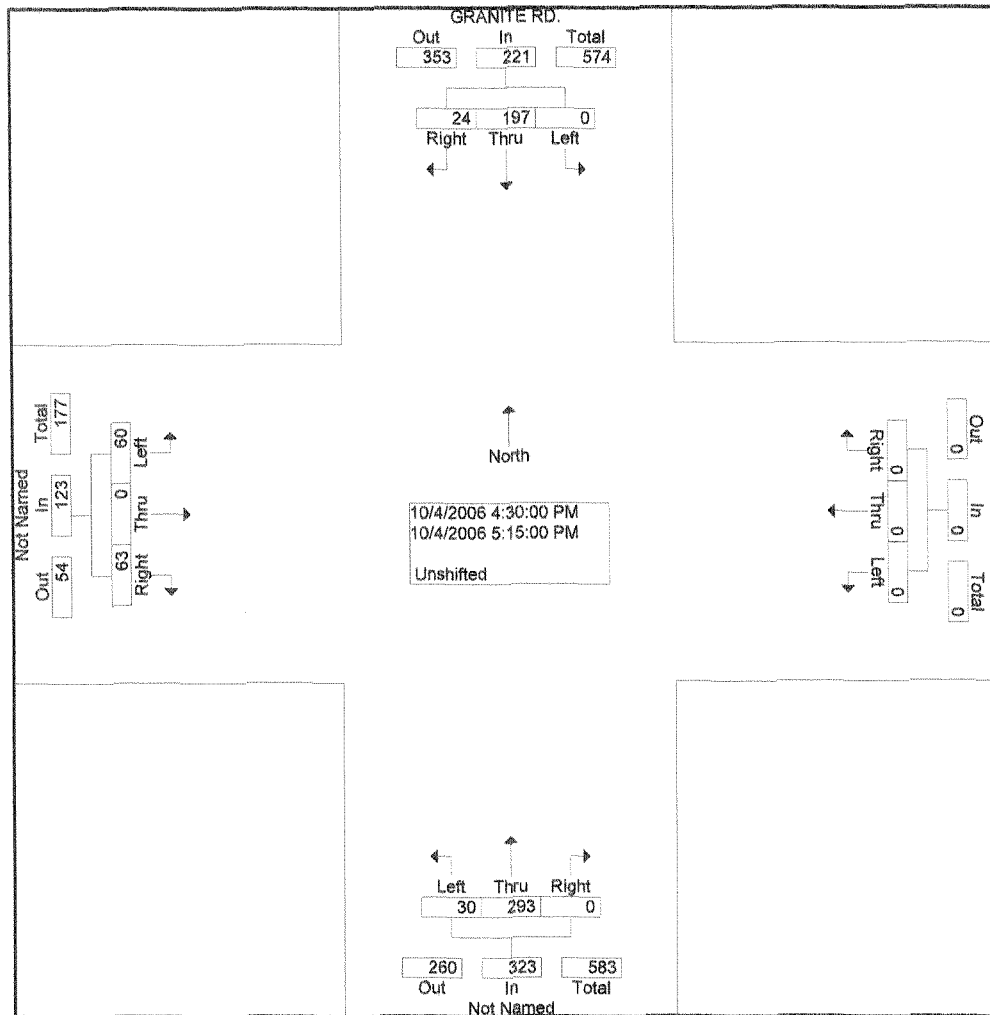

Intersection Turning Movement

Prepared by: Southland Car Counters

N-S STREET: Dominguez Rd

DATE: 08/26/2006

LOCATION: City of Rocklin

E-W STREET: Granite Dr

DAY: SATURDAY

PROJECT# 06-7188-011

LANES:	NORTHBOUND			SOUTHBOUND			EASTBOUND			WESTBOUND			TOTAL
	NL	NT	NR	SL	ST	SR	EL	ET	ER	WL	WT	WR	
	1	2	0	0	2	1	0	1	0	0	0	0	
10:00 AM													
10:15 AM													
10:30 AM													
10:45 AM													
11:00 AM				1		2	0	35		42	0		80
11:15 AM				2		5	3	42		50	1		103
11:30 AM				2		6	5	36		57	3		109
11:45 AM				3		4	1	33		63	2		106
12:00 PM				0		4	2	41		48	2		97
12:15 PM				4		4	4	49		60	4		125
12:30 PM				2		7	1	41		72	2		125
12:45 PM				3		5	1	36		56	3		104
1:00 PM													
1:15 PM													
1:30 PM													
1:45 PM													
2:00 PM													
2:15 PM													
2:30 PM													
2:45 PM													

TOTAL VOLUMES =	NL	NT	NR	SL	ST	SR	EL	ET	ER	WL	WT	WR	TOTAL
	0	0	0	17	0	37	17	313	0	0	448	17	849

NOON Peak Hr Begins at: 1145 AM

PEAK VOLUMES =	0	0	0	9	0	19	8	164	0	0	243	10	453
PEAK HR. FACTOR:	0.000			0.778			0.000			0.855			0.906

CONTROL: One-Way Stop

ALL TRAFFIC DATA INC.

(916)771-8700

FAX 786-2879

Taylor

CITY OF ROCKLIN

File Name : F-Sierra College-Pacific

Site Code : 00000000

Start Date : 10/10/2006

Page No : 1

7

Groups Printed- Unshifted

Start Time	SIERRA COLLEGE BLVD. Southbound				PACIFIC ST. Westbound				Northbound				Eastbound				Int. Total
	Right	Thru	Left	App. Total	Right	Thru	Left	App. Total	Right	Thru	Left	App. Total	Right	Thru	Left	App. Total	
07:00	25	96	9	130	2	16	37	55	27	77	29	133	10	28	10	48	366
07:15	32	120	4	156	8	56	34	98	41	64	21	126	13	45	16	74	454
07:30	54	104	8	166	13	55	63	131	39	57	39	135	14	51	15	80	512
07:45	51	116	6	173	6	63	48	117	32	62	56	150	21	39	20	80	520
Total	162	436	27	625	29	190	182	401	139	260	145	544	58	163	61	282	1852
08:00	30	86	5	121	4	58	27	89	30	60	37	127	19	36	14	69	406
08:15	33	100	4	137	3	62	44	109	36	48	24	108	16	38	28	82	436
08:30	32	85	6	123	3	40	26	69	31	41	44	116	19	41	16	76	384
08:45	20	93	10	123	3	46	39	88	27	55	39	121	20	36	19	75	407
Total	115	364	25	504	13	206	136	355	124	204	144	472	74	151	77	302	1633
16:00	32	87	7	126	7	68	55	130	85	151	43	279	29	72	43	144	679
16:15	32	95	7	134	8	65	46	119	62	129	34	225	23	67	26	116	594
16:30	24	95	3	122	15	71	61	147	59	157	22	238	21	89	50	160	667
16:45	21	64	9	94	6	62	45	113	47	114	21	182	24	77	33	134	523
Total	109	341	26	476	36	266	207	509	253	551	120	924	97	305	152	554	2463
17:00	28	84	8	120	14	65	49	128	64	122	14	200	28	86	27	141	589
17:15	22	86	6	114	10	55	46	111	98	150	28	276	22	86	38	146	647
17:30	19	86	10	115	21	52	41	114	51	153	28	232	20	68	23	111	572
17:45	16	80	3	99	6	43	47	96	40	130	19	189	16	64	27	107	491
Total	85	336	27	448	51	215	183	449	253	555	89	897	86	304	115	505	2299
Grand Total	471	1477	105	2053	129	877	708	1714	769	1570	498	2837	315	923	405	1643	8247
Apprch %	22.9	71.9	5.1		7.5	51.2	41.3		27.1	55.3	17.6		19.2	56.2	24.7		
Total %	5.7	17.9	1.3	24.9	1.6	10.6	8.6	20.8	9.3	19.0	6.0	34.4	3.8	11.2	4.9	19.9	

Start Time	SIERRA COLLEGE BLVD. Southbound				PACIFIC ST. Westbound				Northbound				Eastbound				Int. Total
	Right	Thru	Left	App. Total	Right	Thru	Left	App. Total	Right	Thru	Left	App. Total	Right	Thru	Left	App. Total	
Peak Hour From 07:00 to 08:45 - Peak 1 of 1																	
Intersection	07:15																
Volume	167	426	23	616	31	232	172	435	142	243	153	538	67	171	65	303	1892
Percent	27.1	69.2	3.7		7.1	53.3	39.5		26.4	45.2	28.4		22.1	56.4	21.5		
07:45 Volume	51	116	6	173	6	63	48	117	32	62	56	150	21	39	20	80	520
Peak Factor																	0.910
High Int.	07:45				07:30				07:45				07:30				
Volume	51	116	6	173	13	55	63	131	32	62	56	150	14	51	15	80	
Peak Factor				0.890				0.830				0.897				0.947	

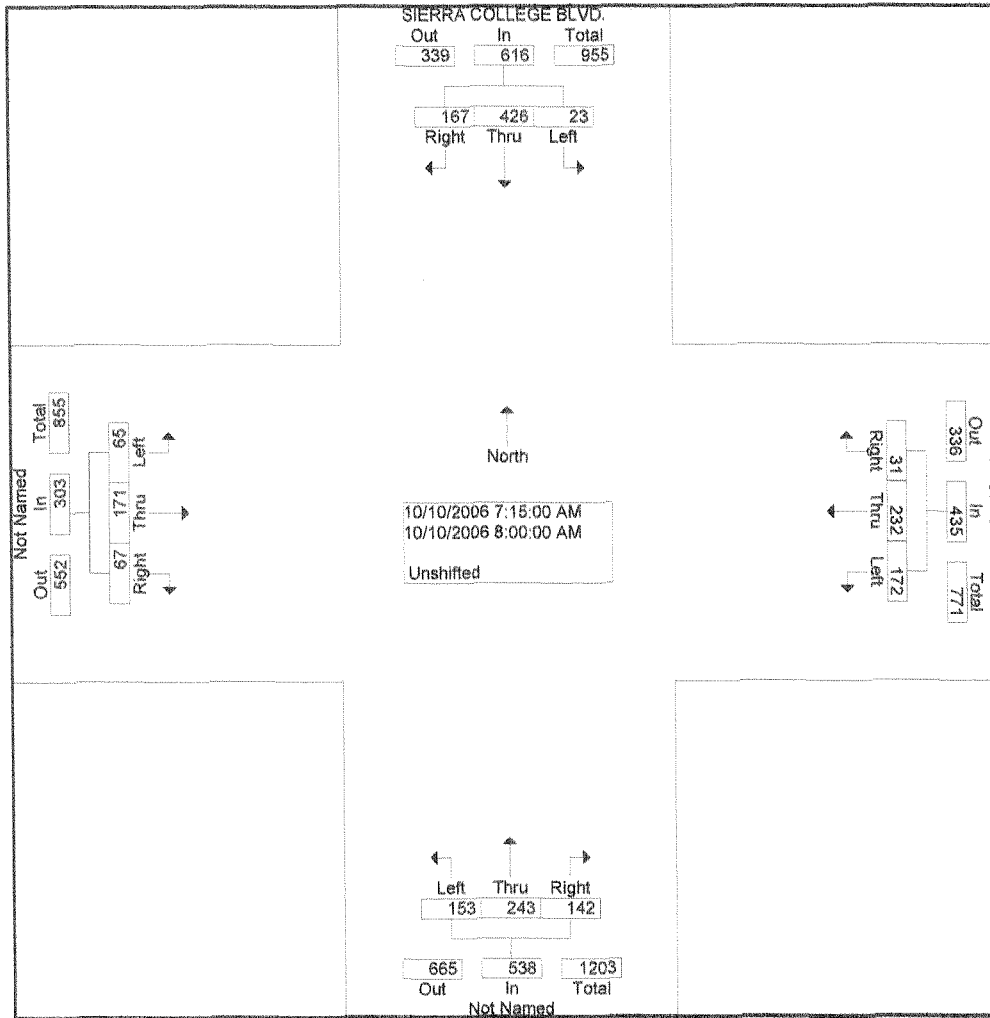

ALL TRAFFIC DATA INC.
(916)771-8700
FAX 786-2879

File Name : F-Sierra College-Pacific
 Site Code : 00000000
 Start Date : 10/10/2006
 Page No : 3

Start Time	SIERRA COLLEGE BLVD. Southbound				PACIFIC ST. Westbound				Northbound				Eastbound				Int. Total
	Right	Thru	Left	App. Total	Right	Thru	Left	App. Total	Right	Thru	Left	App. Total	Right	Thru	Left	App. Total	
Peak Hour From 16:00 to 17:45 - Peak 1 of 1																	
Intersection	16:00																
Volume	109	341	26	476	36	266	207	509	253	551	120	924	97	305	152	554	2463
Percent	22.9	71.6	5.5		7.1	52.3	40.7		27.4	59.6	13.0		17.5	55.1	27.4		
16:00 Volume	32	87	7	126	7	68	55	130	85	151	43	279	29	72	43	144	679
Peak Factor	0.907																
High Int.	16:15																
Volume	32	95	7	134	15	71	61	147	85	151	43	279	21	89	50	160	
Peak Factor	0.888				0.866				0.828				0.866				

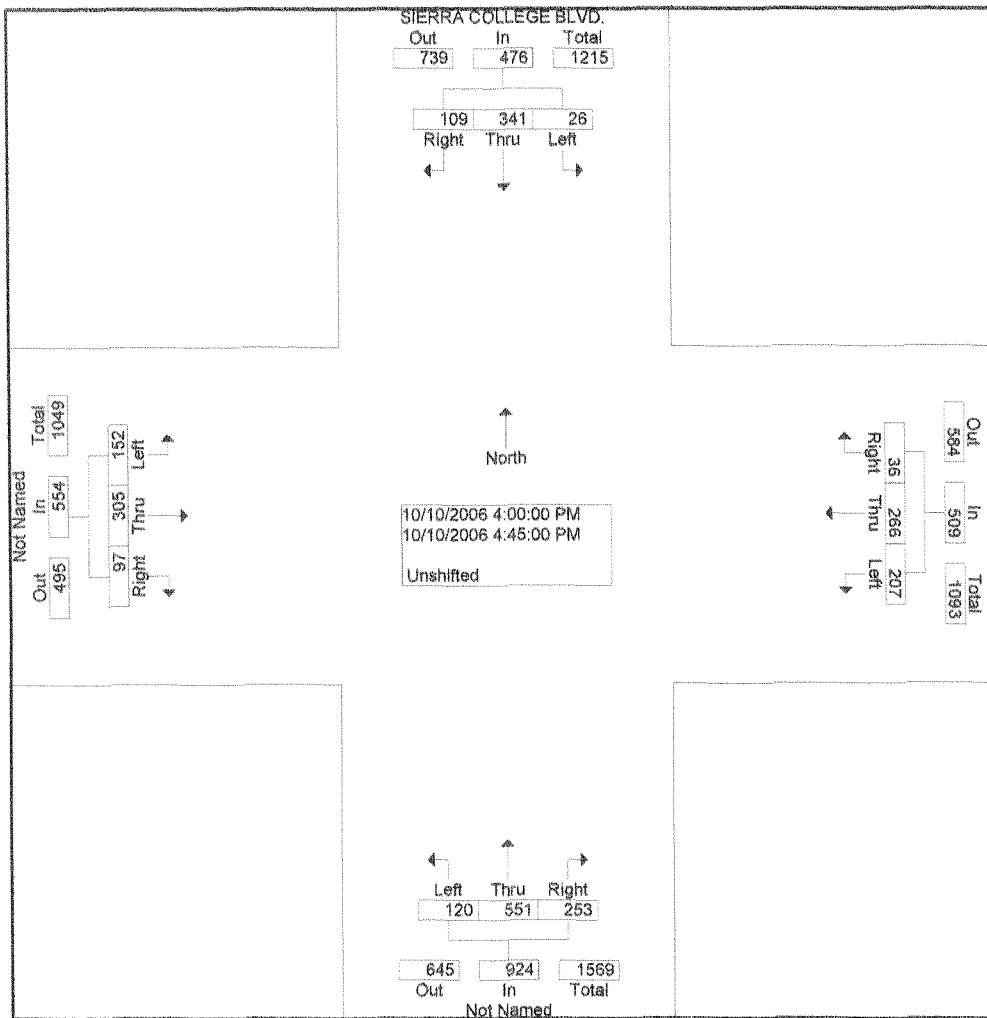

Intersection Turning Movement

Prepared by: Southland Car Counters

N-S STREET: Sierra College Blvd.

DATE: 08/19/2006

LOCATION: City of Rocklin

E-W STREET: Taylor Rd

DAY: SATURDAY

PROJECT# 06-7188-006

LANES:	NORTHBOUND			SOUTHBOUND			EASTBOUND			WESTBOUND			TOTAL
	NL	NT	NR	SL	ST	SR	EL	ET	ER	WL	WT	WR	
	1	1	1	1	1	1	1	1	1	1	1	1	
10:00 AM													
10:15 AM													
10:30 AM													
10:45 AM													
11:00 AM	9	52	15	5	62	18	10	38	5	21	35	5	275
11:15 AM	5	66	22	3	53	24	7	41	9	31	48	2	311
11:30 AM	7	79	16	8	75	17	6	36	5	17	33	4	303
11:45 AM	7	85	24	5	81	13	7	49	9	24	45	7	356
12:00 PM	4	70	12	9	69	17	9	65	5	19	38	3	320
12:15 PM	11	93	19	9	60	19	5	55	4	23	55	9	362
12:30 PM	6	76	14	6	57	11	4	51	10	17	64	5	321
12:45 PM	9	71	17	5	52	14	8	42	9	29	45	6	307
1:00 PM													
1:15 PM													
1:30 PM													
1:45 PM													
2:00 PM													
2:15 PM													
2:30 PM													
2:45 PM													

TOTAL VOLUMES =	NL	NT	NR	SL	ST	SR	EL	ET	ER	WL	WT	WR	TOTAL
	58	592	139	50	509	133	56	377	56	181	363	41	2555

NOON Peak Hr Begins at: 1145 AM

PEAK VOLUMES =	28	324	69	29	267	60	25	220	28	83	202	24	1359
PEAK HR. FACTOR:		0.856		0.899			0.864			0.888			0.939

CONTROL: Signalized

ALL TRAFFIC DATA INC.

(916)771-8700

FAX 786-2879

CITY OF ROCKLIN

File Name : F-Sierra College-Brace

Site Code : 00000000

Start Date : 10/5/2006

Page No : 1

8

Groups Printed- Unshifted

Start Time	SIERRA COLLEGE BLVD. Southbound				BRACE RD. Westbound				Northbound				Eastbound				Int. Total
	Right	Thru	Left	App. Total	Right	Thru	Left	App. Total	Right	Thru	Left	App. Total	Right	Thru	Left	App. Total	
07:00	0	108	17	125	18	0	15	33	9	97	0	106	4	0	0	4	268
07:15	0	126	19	145	15	0	21	36	5	99	0	104	5	0	0	5	290
07:30	0	136	25	161	29	0	19	48	13	94	0	107	15	0	0	15	331
07:45	0	121	13	134	15	0	12	27	8	93	0	101	13	0	0	13	275
Total	0	491	74	565	77	0	67	144	35	383	0	418	37	0	0	37	1164
08:00	0	149	11	160	12	0	15	27	5	98	0	103	18	0	0	18	308
08:15	0	148	19	167	20	0	21	41	10	95	0	105	12	0	0	12	325
08:30	0	126	15	141	17	0	18	35	9	99	0	108	19	0	0	19	303
08:45	0	119	21	140	10	0	19	29	18	97	0	115	6	0	0	6	290
Total	0	542	66	608	59	0	73	132	42	389	0	431	55	0	0	55	1226
16:00	0	122	23	145	26	0	18	44	22	146	0	168	18	0	0	18	375
16:15	0	126	20	146	23	0	12	35	12	143	0	155	15	0	0	15	351
16:30	0	128	20	148	24	0	24	48	19	139	0	158	26	0	0	26	380
16:45	0	121	25	146	16	0	16	32	31	123	0	154	19	0	0	19	351
Total	0	497	88	585	89	0	70	159	84	551	0	635	78	0	0	78	1457
17:00	0	137	21	158	28	0	17	45	24	147	0	171	28	0	0	28	402
17:15	0	128	18	146	24	0	18	42	25	158	0	183	14	0	0	14	385
17:30	0	111	21	132	21	0	24	45	27	146	0	173	23	0	0	23	373
17:45	0	72	9	81	21	0	19	40	21	125	0	146	5	0	0	5	272
Total	0	448	69	517	94	0	78	172	97	576	0	673	70	0	0	70	1432
Grand Total	0	1978	297	2275	319	0	288	607	258	1899	0	2157	240	0	0	240	5279
Apprch %	0.0	86.9	13.1		52.6	0.0	47.4		12.0	88.0	0.0		100.0	0.0	0.0		
Total %	0.0	37.5	5.6	43.1	6.0	0.0	5.5	11.5	4.9	36.0	0.0	40.9	4.5	0.0	0.0	4.5	

Start Time	SIERRA COLLEGE BLVD. Southbound				BRACE RD. Westbound				Northbound				Eastbound				Int. Total
	Right	Thru	Left	App. Total	Right	Thru	Left	App. Total	Right	Thru	Left	App. Total	Right	Thru	Left	App. Total	
Peak Hour From 07:00 to 08:45 - Peak 1 of 1																	
Intersection	07:30																
Volume	0	554	68	622	76	0	67	143	36	380	0	416	58	0	0	58	1239
Percent	0.0	89.1	10.9		53.1	0.0	46.9		8.7	91.3	0.0		100.0	0.0	0.0		
07:30 Volume	0	136	25	161	29	0	19	48	13	94	0	107	15	0	0	15	331
Peak Factor																	0.936
High Int.	08:15				07:30				07:30				08:00				
Volume	0	148	19	167	29	0	19	48	13	94	0	107	18	0	0	18	
Peak Factor					0.931				0.745				0.972				0.806

ALL TRAFFIC DATA INC.

(916)771-8700

FAX 786-2879

File Name : F-Sierra College-Brace

Site Code : 00000000

Start Date : 10/5/2006

Page No : 2

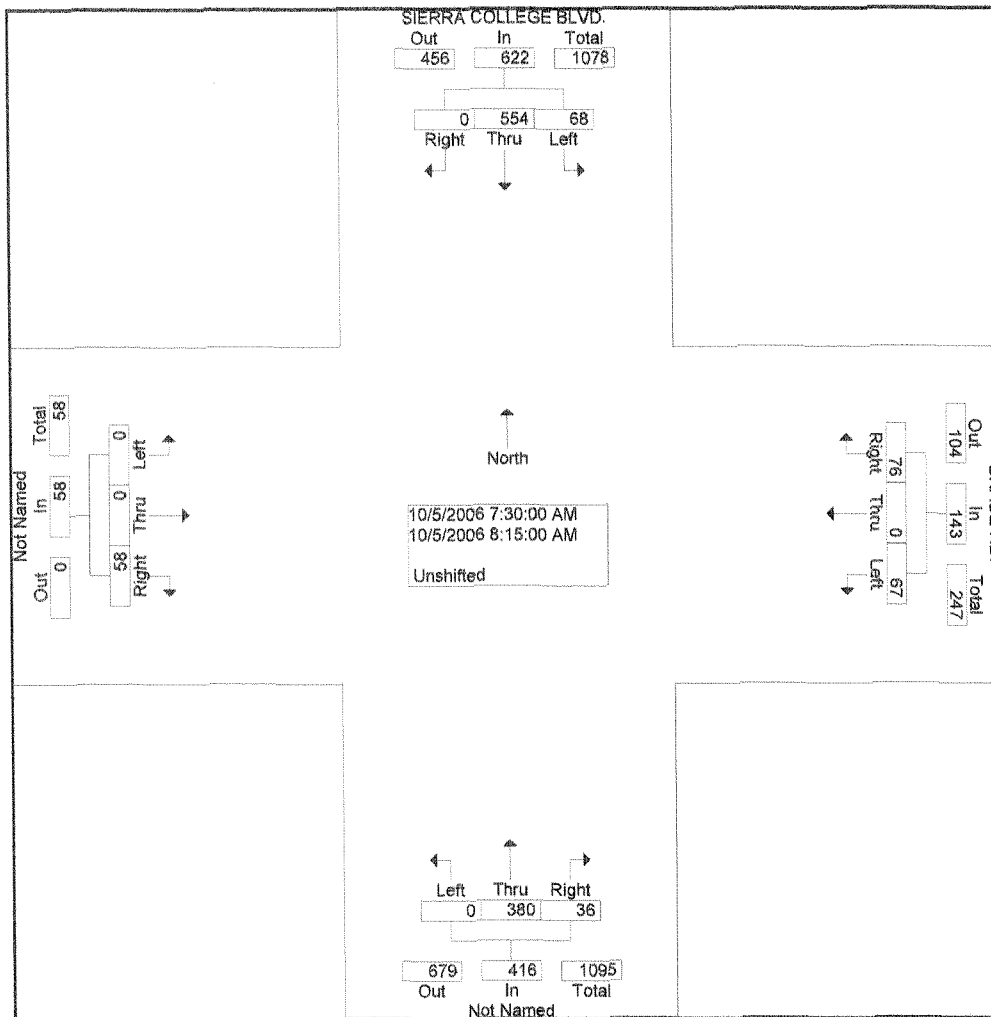

ALL TRAFFIC DATA INC.

(916)771-8700

FAX 786-2879

File Name : F-Sierra College-Brace

Site Code : 00000000

Start Date : 10/5/2006

Page No : 3

Start Time	SIERRA COLLEGE BLVD. Southbound				BRACE RD. Westbound				Northbound				Eastbound				Int. Total
	Right	Thru	Left	App. Total	Right	Thru	Left	App. Total	Right	Thru	Left	App. Total	Right	Thru	Left	App. Total	
Peak Hour From 16:00 to 17:45 - Peak 1 of 1																	
Intersection 16:30																	
Volume	0	514	84	598	92	0	75	167	99	567	0	666	87	0	0	87	1518
Percent	0.0	86.0	14.0		55.1	0.0	44.9		14.9	85.1	0.0		100.0	0.0	0.0		
17:00 Volume	0	137	21	158	28	0	17	45	24	147	0	171	28	0	0	28	402
Peak Factor	0.944																
High Int. 17:00																	
Volume	0	137	21	158	16:30 24	0	24	48	17:15 25	158	0	183	17:00 28	0	0	28	
Peak Factor	0.946				0.870				0.910				0.777				

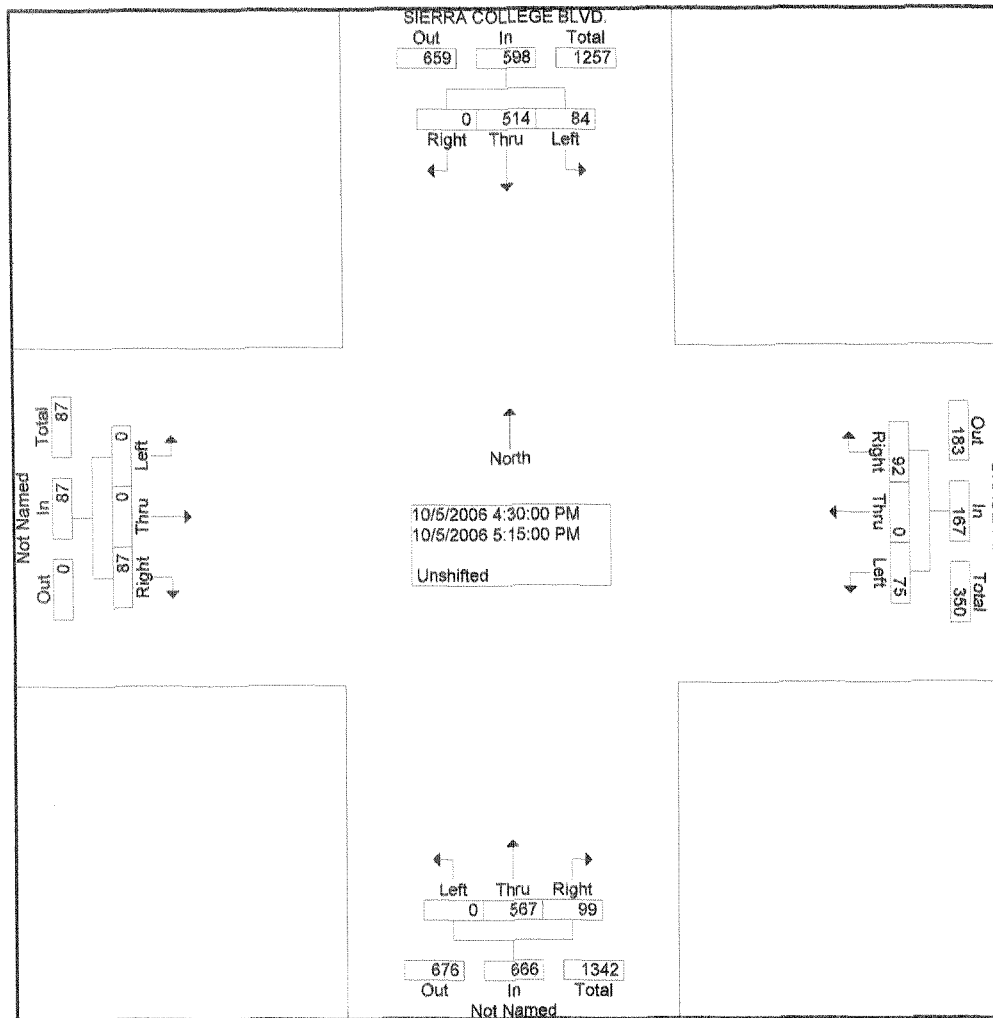

Intersection Turning Movement

Prepared by: Southland Car Counters

N-S STREET: Sierra College Blvd. DATE: 08/19/2006 LOCATION: City of Rocklin
 E-W STREET: Brace Rd DAY: SATURDAY PROJECT# 06-7188-005

LANES:	NORTHBOUND			SOUTHBOUND			EASTBOUND			WESTBOUND			TOTAL
	NL	NT	NR	SL	ST	SR	EL	ET	ER	WL	WT	WR	
	0	1	1	1	1	0	0	0	1	1	0	1	
10:00 AM													
10:15 AM													
10:30 AM													
10:45 AM													
11:00 AM		66	8	10	87				5	11		9	196
11:15 AM		78	5	7	81				5	20		13	209
11:30 AM		90	2	11	96				3	11		6	219
11:45 AM		100	3	9	104				1	7		6	230
12:00 PM		90	2	6	92				4	10		9	213
12:15 PM		103	4	5	82				6	15		14	229
12:30 PM		97	6	9	72				3	12		8	207
12:45 PM		88	9	13	60				4	8		7	189
1:00 PM													
1:15 PM													
1:30 PM													
1:45 PM													
2:00 PM													
2:15 PM													
2:30 PM													
2:45 PM													

TOTAL VOLUMES =	NL	NT	NR	SL	ST	SR	EL	ET	ER	WL	WT	WR	TOTAL
	0	712	39	70	674	0	0	0	31	94	0	72	1692

NOON Peak Hr Begins at: 1130 AM

PEAK VOLUMES =	0	383	11	31	374	0	0	0	14	43	0	35	891
PEAK HR. FACTOR:		0.921			0.896				0.583		0.672		0.968

CONTROL: Signalized

ALL TRAFFIC DATA INC.

(916)771-8700

FAX 786-2879

CITY OF ROCKLIN

File Name : F-Sierra Coll-Granite Rd

Site Code : 00000000

Start Date : 10/5/2006

Page No : 1

9

Groups Printed- Unshifted

Start Time	SIERRA COLLEGE BLVD. Southbound				GRANITE RD. Westbound				Northbound				Eastbound				Int. Total
	Right	Thru	Left	App. Total	Right	Thru	Left	App. Total	Right	Thru	Left	App. Total	Right	Thru	Left	App. Total	
07:00	7	106	17	130	9	5	28	42	22	73	15	110	15	4	3	22	304
07:15	15	106	16	137	5	5	33	43	23	87	31	141	8	4	5	17	338
07:30	9	111	22	142	7	8	34	49	20	88	27	135	4	7	10	21	347
07:45	14	126	31	171	10	9	27	46	19	107	56	182	12	7	10	29	428
Total	45	449	86	580	31	27	122	180	84	355	129	568	39	22	28	89	1417
08:00	19	123	22	164	16	7	36	59	11	84	39	134	30	8	5	43	400
08:15	21	116	28	165	8	6	29	43	24	89	30	143	15	3	9	27	378
08:30	17	108	26	151	5	4	33	42	11	92	24	127	12	5	10	27	347
08:45	22	97	24	143	5	5	35	45	18	91	25	134	31	10	20	61	383
Total	79	444	100	623	34	22	133	189	64	356	118	538	88	26	44	158	1508
16:00	18	116	16	150	6	4	22	32	12	147	33	192	46	5	27	78	452
16:15	15	123	12	150	6	5	27	38	18	116	23	157	41	3	25	69	414
16:30	20	116	21	157	8	3	27	38	15	116	24	155	36	6	28	70	420
16:45	20	124	15	159	7	4	20	31	19	115	22	156	34	6	31	71	417
Total	73	479	64	616	27	16	96	139	64	494	102	660	157	20	111	288	1703
17:00	13	135	17	165	13	2	34	49	23	131	26	180	61	12	37	110	504
17:15	8	139	19	166	5	7	36	48	17	157	18	192	41	7	34	82	488
17:30	26	106	19	151	10	7	22	39	13	123	30	166	42	7	29	78	434
17:45	8	71	6	85	7	2	23	32	20	105	28	153	36	7	24	67	337
Total	55	451	61	567	35	18	115	168	73	516	102	691	180	33	124	337	1763
Grand Total	252	1823	311	2386	127	83	466	676	285	1721	451	2457	464	101	307	872	6391
Apprch %	10.6	76.4	13.0		18.8	12.3	68.9		11.6	70.0	18.4		53.2	11.6	35.2		
Total %	3.9	28.5	4.9	37.3	2.0	1.3	7.3	10.6	4.5	26.9	7.1	38.4	7.3	1.6	4.8	13.6	

Start Time	SIERRA COLLEGE BLVD. Southbound				GRANITE RD. Westbound				Northbound				Eastbound				Int. Total
	Right	Thru	Left	App. Total	Right	Thru	Left	App. Total	Right	Thru	Left	App. Total	Right	Thru	Left	App. Total	
Peak Hour From 07:00 to 08:45 - Peak 1 of 1																	
Intersection	07:30																
Volume	63	476	103	642	41	30	126	197	74	368	152	594	61	25	34	120	1553
Percent	9.8	74.1	16.0		20.8	15.2	64.0		12.5	62.0	25.6		50.8	20.8	28.3		
07:45 Volume	14	126	31	171	10	9	27	46	19	107	56	182	12	7	10	29	428
Peak Factor	0.907																
High Int.	07:45																
Volume	14	126	31	171	16	7	36	59	19	107	56	182	30	8	5	43	
Peak Factor	0.939				0.835				0.816				0.698				

ALL TRAFFIC DATA INC.

(916)771-8700

FAX 786-2879

File Name : F-Sierra Coll-Granite Rd

Site Code : 00000000

Start Date : 10/5/2006

Page No : 2

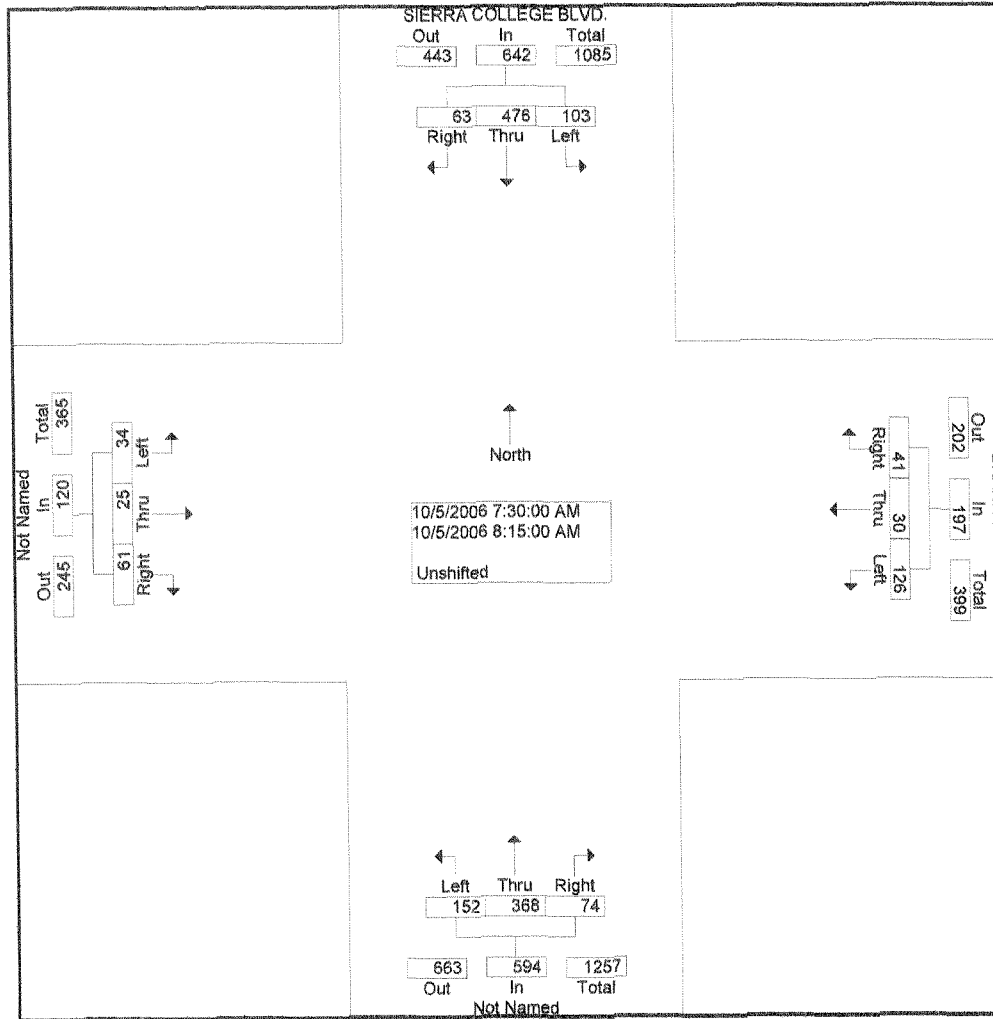

ALL TRAFFIC DATA INC.
(916)771-8700
FAX 786-2879

File Name : F-Sierra Coll-Granite Rd
 Site Code : 00000000
 Start Date : 10/5/2006
 Page No : 3

Start Time	SIERRA COLLEGE BLVD. Southbound				GRANITE RD. Westbound				Northbound				Eastbound				Int. Total	
	Right	Thru	Left	App. Total	Right	Thru	Left	App. Total	Right	Thru	Left	App. Total	Right	Thru	Left	App. Total		
Peak Hour From 16:00 to 17:45 - Peak 1 of 1																		
Intersection	16:45																	
Volume	67	504	70	641	35	20	112	167	72	526	96	694	178	32	131	341	1843	
Percent	10.5	78.6	10.9		21.0	12.0	67.1		10.4	75.8	13.8		52.2	9.4	38.4			
17:00 Volume	13	135	17	165	13	2	34	49	23	131	26	180	61	12	37	110	504	
Peak Factor																	0.914	
High Int.	17:15				17:00				17:15				17:00					
Volume	8	139	19	166	13	2	34	49	17	157	18	192	61	12	37	110		
Peak Factor				0.965				0.852				0.904				0.775		

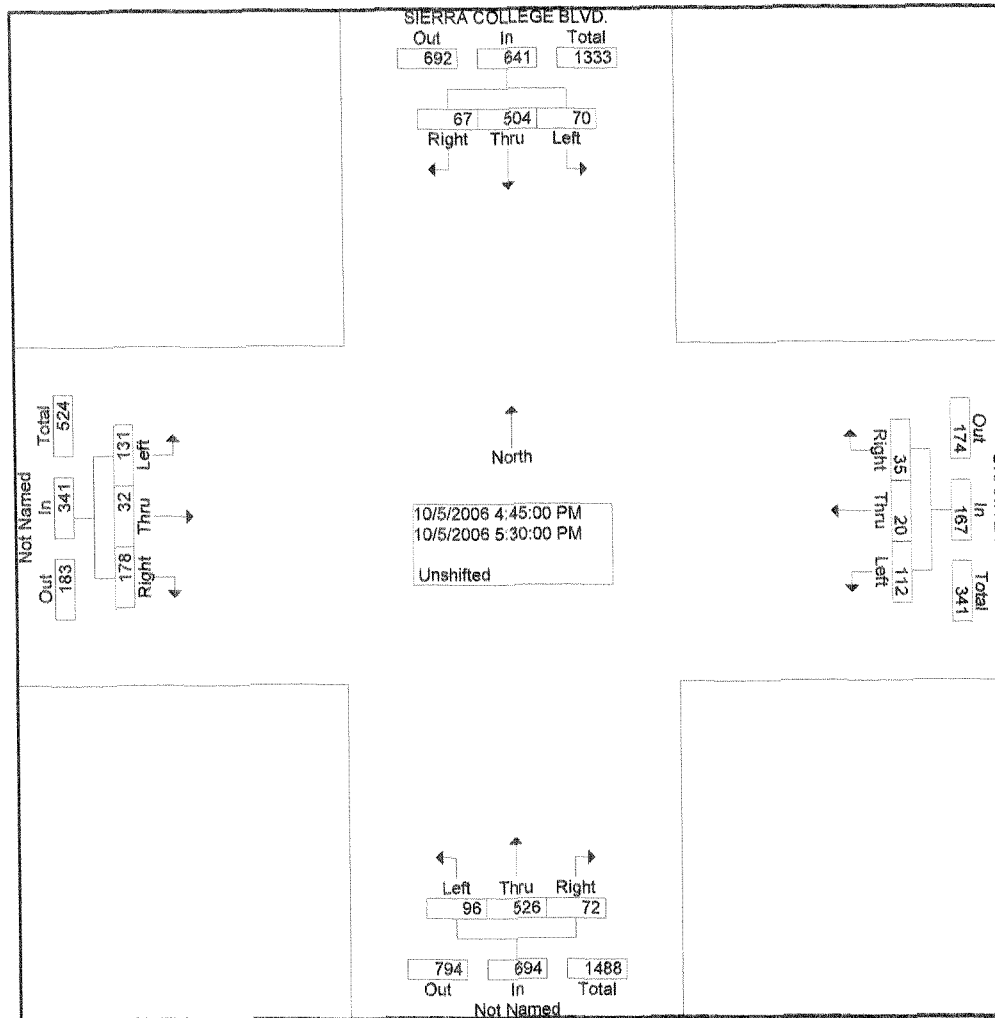

Intersection Turning Movement

Prepared by: Southland Car Counters

N-S STREET: Sierra College Blvd.

DATE: 08/19/2006

LOCATION: City of Rocklin

E-W STREET: Granite Dr

DAY: SATURDAY

PROJECT# 06-7188-004

LANES:	NORTHBOUND			SOUTHBOUND			EASTBOUND			WESTBOUND			TOTAL
	NL	NT	NR	SL	ST	SR	EL	ET	ER	WL	WT	WR	
	1	1	1	1	1	1	1	1	2	1	1	1	

10:00 AM													
10:15 AM													
10:30 AM													
10:45 AM													
11:00 AM	24	46	23	15	42	26	21	10	17	31	6	2	263
11:15 AM	35	56	32	23	50	37	31	7	14	43	4	3	335
11:30 AM	46	62	17	16	55	29	27	6	16	28	2	5	309
11:45 AM	38	78	22	19	64	31	24	5	25	36	4	7	353
12:00 PM	31	71	20	12	70	27	20	6	13	31	2	4	307
12:15 PM	44	84	32	11	77	22	26	5	17	29	5	9	361
12:30 PM	33	65	20	14	67	18	37	3	23	23	7	5	315
12:45 PM	25	56	16	11	55	14	44	4	18	18	3	5	269
1:00 PM													
1:15 PM													
1:30 PM													
1:45 PM													
2:00 PM													
2:15 PM													
2:30 PM													
2:45 PM													

TOTAL VOLUMES =	NL	NT	NR	SL	ST	SR	EL	ET	ER	WL	WT	WR	TOTAL
	276	518	182	121	480	204	230	46	143	239	33	40	2512

NOON Peak Hr Begins at: 1145 AM

PEAK VOLUMES =	146	298	94	56	278	98	107	19	78	119	18	25	1336
PEAK HR. FACTOR:		0.841			0.947			0.810			0.862		0.925

CONTROL: Signalized

ALL TRAFFIC DATA INC.

(916)771-8700

FAX 786-2879

CITY OF ROCKLIN

File Name : F-Sierra College-I80 wb ramps

Site Code : 00000000

Start Date : 10/5/2006

Page No : 1

10

Groups Printed- Unshifted

Start Time	SIERRA COLLEGE BLVD. Southbound				I80 WB RAMPS Westbound				Northbound				Eastbound				Int. Total
	Right	Thru	Left	App. Total	Right	Thru	Left	App. Total	Right	Thru	Left	App. Total	Right	Thru	Left	App. Total	
07:00	0	96	42	138	38	0	83	121	6	80	0	86	0	0	0	0	345
07:15	0	104	43	147	53	0	116	169	6	82	0	88	0	0	0	0	404
07:30	0	102	39	141	42	0	104	146	6	88	0	94	0	0	0	0	381
07:45	0	127	59	186	73	0	88	161	9	115	0	124	0	0	0	0	471
Total	0	429	183	612	206	0	391	597	27	365	0	392	0	0	0	0	1601
08:00	0	125	65	190	43	0	67	110	14	89	0	103	0	0	0	0	403
08:15	0	95	69	164	46	0	82	128	10	93	0	103	0	0	0	0	395
08:30	0	87	56	143	55	0	71	126	16	80	0	96	0	0	0	0	365
08:45	0	103	62	165	44	0	96	140	11	83	0	94	0	0	0	0	399
Total	0	410	252	662	188	0	316	504	51	345	0	396	0	0	0	0	1562
16:00	0	108	66	174	42	0	68	110	6	141	0	147	0	0	0	0	431
16:15	0	143	56	199	47	0	57	104	11	125	0	136	0	0	0	0	439
16:30	0	125	61	186	34	0	69	103	12	118	0	130	0	0	0	0	419
16:45	0	138	36	174	41	0	83	124	9	116	0	125	0	0	0	0	423
Total	0	514	219	733	164	0	277	441	38	500	0	538	0	0	0	0	1712
17:00	0	158	65	223	42	0	83	125	6	141	0	147	0	0	0	0	495
17:15	0	156	65	221	41	0	77	118	13	149	0	162	0	0	0	0	501
17:30	0	124	47	171	35	0	77	112	10	127	0	137	0	0	0	0	420
17:45	0	89	46	135	31	0	80	111	6	122	0	128	0	0	0	0	374
Total	0	527	223	750	149	0	317	466	35	539	0	574	0	0	0	0	1790
Grand Total	0	1880	877	2757	707	0	1301	2008	151	1749	0	1900	0	0	0	0	6665
Apprch %	0.0	68.2	31.8		35.2	0.0	64.8		7.9	92.1	0.0		0.0	0.0	0.0		
Total %	0.0	28.2	13.2	41.4	10.6	0.0	19.5	30.1	2.3	26.2	0.0	28.5	0.0	0.0	0.0	0.0	

Start Time	SIERRA COLLEGE BLVD. Southbound				I80 WB RAMPS Westbound				Northbound				Eastbound				Int. Total
	Right	Thru	Left	App. Total	Right	Thru	Left	App. Total	Right	Thru	Left	App. Total	Right	Thru	Left	App. Total	
Peak Hour From 07:00 to 08:45 - Peak 1 of 1																	
Intersection	07:15																
Volume	0	458	206	664	211	0	375	586	35	374	0	409	0	0	0	0	1659
Percent	0.0	69.0	31.0		36.0	0.0	64.0		8.6	91.4	0.0		0.0	0.0	0.0		
07:45 Volume	0	127	59	186	73	0	88	161	9	115	0	124	0	0	0	0	471
Peak Factor																	0.881
High Int.	08:00				07:15				07:45				6:45:00 AM				
Volume	0	125	65	190	53	0	116	169	9	115	0	124					
Peak Factor	0.874				0.867				0.825								

ALL TRAFFIC DATA INC.

(916)771-8700

FAX 786-2879

File Name : F-Sierra College-I80 wb ramps

Site Code : 00000000

Start Date : 10/5/2006

Page No : 2

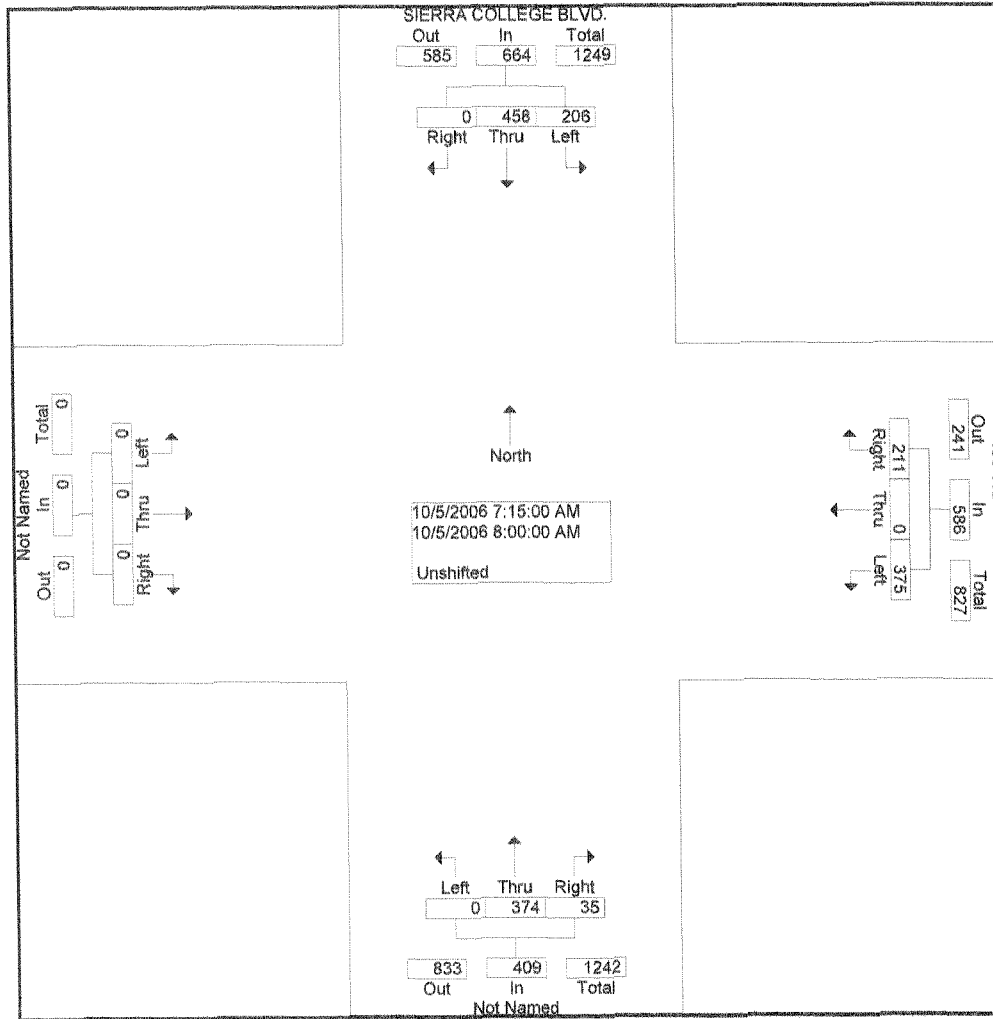

ALL TRAFFIC DATA INC.
(916)771-8700
FAX 786-2879

File Name : F-Sierra College-180 wb ramps
 Site Code : 00000000
 Start Date : 10/5/2006
 Page No : 3

Start Time	SIERRA COLLEGE BLVD. Southbound				180 WB RAMPS Westbound				Northbound				Eastbound				Int. Total
	Right	Thru	Left	App. Total	Right	Thru	Left	App. Total	Right	Thru	Left	App. Total	Right	Thru	Left	App. Total	
Peak Hour From 16:00 to 17:45 - Peak 1 of 1																	
Intersection	16:45																
Volume	0	576	213	789	159	0	320	479	38	533	0	571	0	0	0	0	1839
Percent	0.0	73.0	27.0		33.2	0.0	66.8		6.7	93.3	0.0		0.0	0.0	0.0		
17:15 Volume	0	156	65	221	41	0	77	118	13	149	0	162	0	0	0	0	501
Peak Factor	0.918																
High Int.	17:00																
Volume	0	158	65	223	42	0	83	125	13	149	0	162					
Peak Factor				0.885				0.958				0.881					

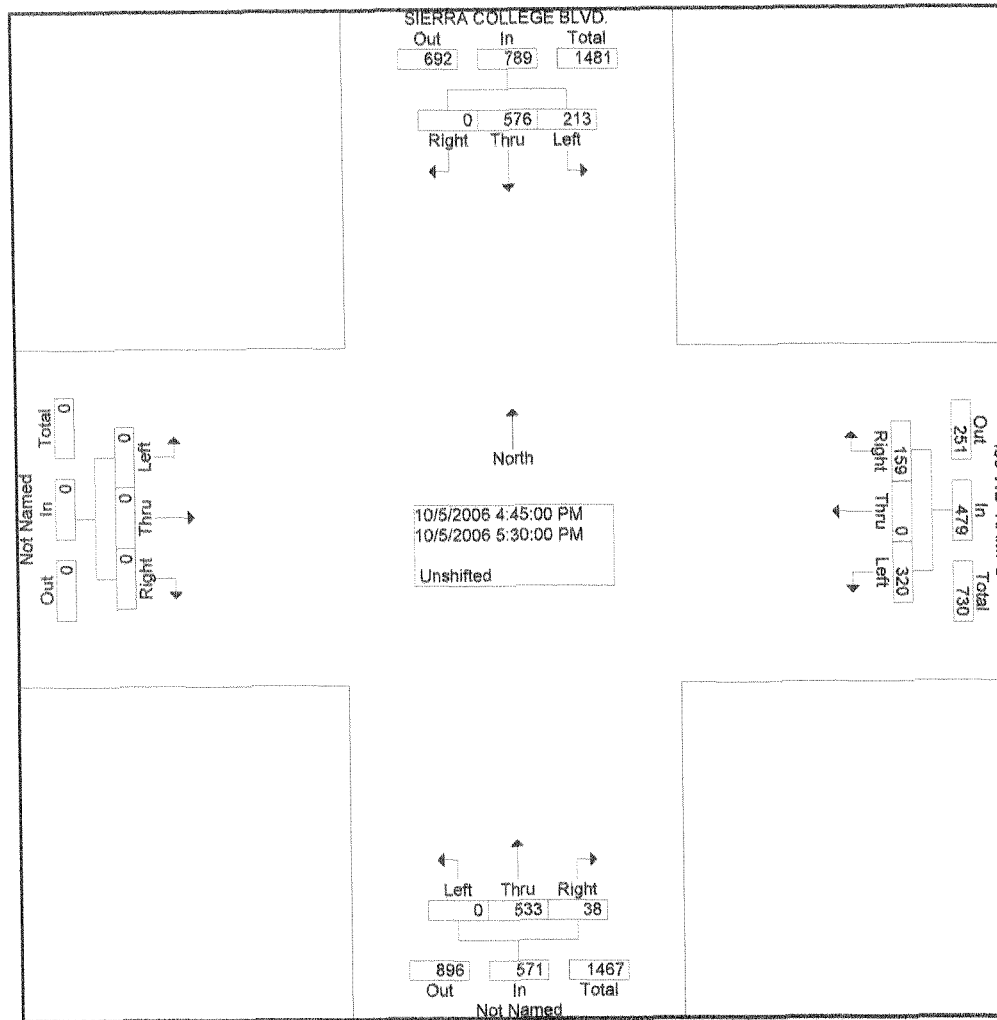

Intersection Turning Movement

Prepared by: Southland Car Counters

N-S STREET: Sierra College Blvd.

DATE: 08/19/2006

LOCATION: City of Rocklin

E-W STREET: I-80 SB Ramp

DAY: SATURDAY

PROJECT# 06-7188-003

LANES:	NORTHBOUND			SOUTHBOUND			EASTBOUND			WESTBOUND			TOTAL
	NL	NT	NR	SL	ST	SR	EL	ET	ER	WL	WT	WR	
	1	1	0	0	1	1	0	1	0	.5	.5	1	
10:00 AM													
10:15 AM													
10:30 AM													
10:45 AM													
11:00 AM		100	15	39	68					24		2	248
11:15 AM		107	22	45	61					48		8	291
11:30 AM		85	27	36	88					41		4	281
11:45 AM		114	19	28	52					21		7	241
12:00 PM		119	26	31	65					46		8	295
12:15 PM		104	13	34	83					45		5	284
12:30 PM		113	10	27	75					31		9	265
12:45 PM		153	20	21	96					40		6	336
1:00 PM													
1:15 PM													
1:30 PM													
1:45 PM													
2:00 PM													
2:15 PM													
2:30 PM													
2:45 PM													

TOTAL VOLUMES =	NL	NT	NR	SL	ST	SR	EL	ET	ER	WL	WT	WR	TOTAL
	0	895	152	261	588	0	0	0	0	296	0	49	2241

NOON Peak Hr Begins at: 1200 PM

PEAK VOLUMES =	0	489	69	113	319	0	0	0	0	162	0	28	1180
PEAK HR. FACTOR:		0.806			0.923			0.000			0.880		0.878

CONTROL: Signalized

ALL TRAFFIC DATA INC.

(916)771-8700

FAX 786-2879

CITY OF ROCKLIN

File Name : F-Sierra College-180 EB

Site Code : 00000000

Start Date : 11/5/2006

Page No : 1

Groups Printed- Unshifted

Start Time	SIERRA COLLEGE BLVD. Southbound				180 EB RAMPS Westbound				Northbound				Eastbound				Int. Total
	Right	Thru	Left	App. Total	Right	Thru	Left	App. Total	Right	Thru	Left	App. Total	Right	Thru	Left	App. Total	
07:00	23	149	0	172	0	0	0	0	0	59	50	109	4	0	35	39	320
07:15	25	189	0	214	0	0	0	0	0	64	72	136	9	0	51	60	410
07:30	24	176	0	200	0	0	0	0	0	56	91	147	42	0	56	98	445
07:45	29	200	0	229	0	0	0	0	0	86	59	145	49	0	60	109	483
Total	101	714	0	815	0	0	0	0	0	265	272	537	104	0	202	306	1658
08:00	44	151	0	195	0	0	0	0	0	83	48	131	15	0	39	54	380
08:15	45	132	0	177	0	0	0	0	0	71	53	124	17	0	53	70	371
08:30	34	128	0	162	0	0	0	0	0	57	52	109	6	0	34	40	311
08:45	39	163	0	202	0	0	0	0	0	46	61	107	14	0	45	59	368
Total	162	574	0	736	0	0	0	0	0	257	214	471	52	0	171	223	1430
16:00	48	135	0	183	0	0	0	0	0	94	79	173	9	0	58	67	423
16:15	55	149	0	204	0	0	0	0	0	89	91	180	5	0	53	58	442
16:30	42	146	0	188	0	0	0	0	0	81	78	159	7	0	54	61	408
16:45	58	158	0	216	0	0	0	0	0	84	78	162	9	0	48	57	435
Total	203	588	0	791	0	0	0	0	0	348	326	674	30	0	213	243	1708
17:00	54	170	0	224	0	0	0	0	0	96	94	190	10	0	58	68	482
17:15	60	185	0	245	0	0	0	0	0	114	93	207	4	0	57	61	513
17:30	52	147	0	199	0	0	0	0	0	93	69	162	8	0	48	56	417
17:45	36	133	0	169	0	0	0	0	0	77	99	176	2	0	52	54	399
Total	202	635	0	837	0	0	0	0	0	380	355	735	24	0	215	239	1811
Grand Total	668	2511	0	3179	0	0	0	0	0	1250	1167	2417	210	0	801	1011	6607
Apprch %	21.0	79.0	0.0		0.0	0.0	0.0			0.0	51.7	48.3			20.8	0.0	
Total %	10.1	38.0	0.0	48.1	0.0	0.0	0.0	0.0	0.0	0.0	18.9	17.7	36.6	3.2	0.0	12.1	15.3

Start Time	SIERRA COLLEGE BLVD. Southbound				180 EB RAMPS Westbound				Northbound				Eastbound				Int. Total
	Right	Thru	Left	App. Total	Right	Thru	Left	App. Total	Right	Thru	Left	App. Total	Right	Thru	Left	App. Total	
Peak Hour From 07:00 to 08:45 - Peak 1 of 1																	
Intersection	07:15																
Volume	122	716	0	838	0	0	0	0	0	289	270	559	115	0	206	321	1718
Percent	14.6	85.4	0.0		0.0	0.0	0.0			0.0	51.7	48.3			35.8	0.0	64.2
07:45 Volume	29	200	0	229	0	0	0	0	0	86	59	145	49	0	60	109	483
Peak Factor																	0.889
High Int.	07:45				6:45:00 AM					07:30			07:45				
Volume	29	200	0	229	0	0	0	0	0	56	91	147	49	0	60	109	
Peak Factor				0.915								0.951					0.736

ALL TRAFFIC DATA INC.

(916)771-8700

FAX 786-2879

File Name : F-Sierra College-180 EB

Site Code : 00000000

Start Date : 11/5/2006

Page No : 2

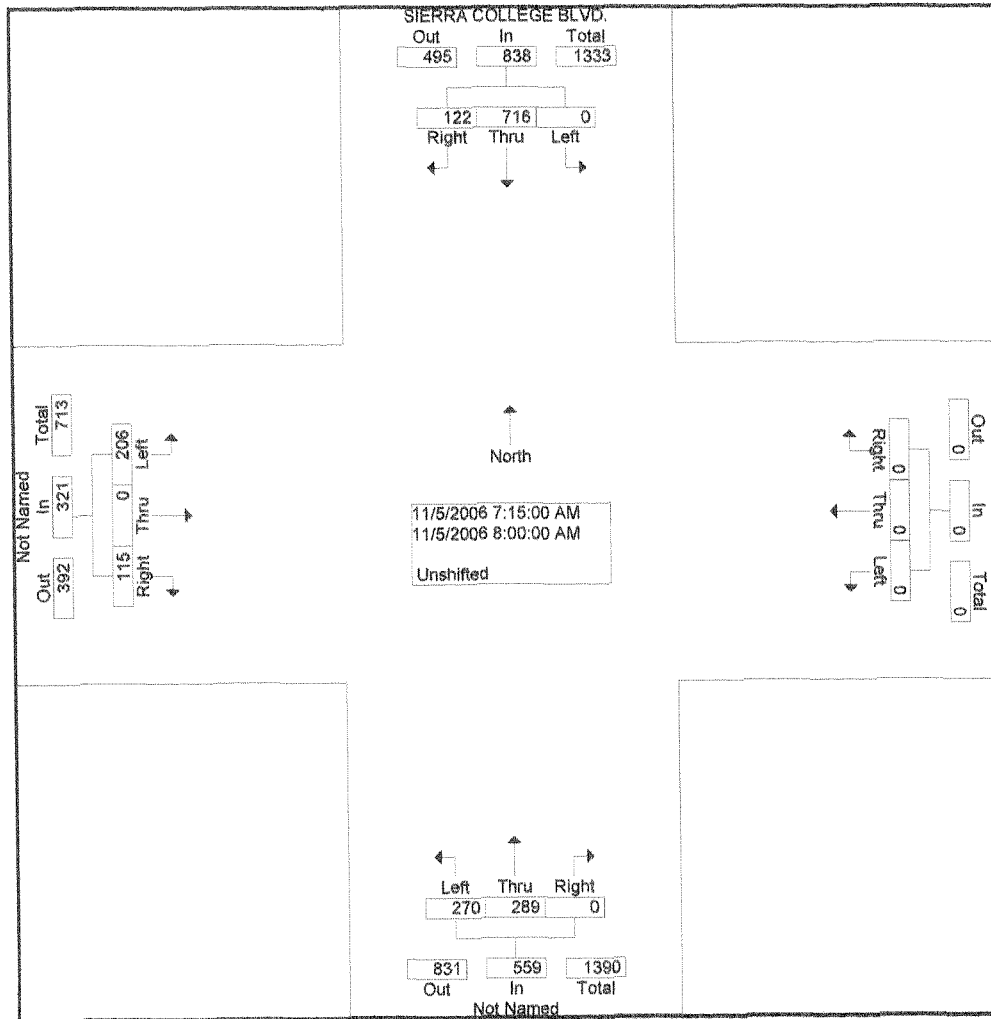

ALL TRAFFIC DATA INC.
 (916)771-8700
 FAX 786-2879

File Name : F-Sierra College-I80 EB
 Site Code : 00000000
 Start Date : 11/5/2006
 Page No : 3

	SIERRA COLLEGE BLVD. Southbound				I80 EB RAMPS Westbound				Northbound				Eastbound				Int. Total	
	Start Time	Right	Thru	Left	App. Total	Right	Thru	Left	App. Total	Right	Thru	Left	App. Total	Right	Thru	Left		App. Total
Peak Hour From 16:00 to 17:45 - Peak 1 of 1																		
Intersection	16:45																	
Volume	224	660	0	884	0	0	0	0	0	387	334	721	31	0	211	242	1847	
Percent	25.3	74.7	0.0		0.0	0.0	0.0		0.0	53.7	46.3		12.8	0.0	87.2			
17:15 Volume	60	185	0	245	0	0	0	0	0	114	93	207	4	0	57	61	513	
Peak Factor																	0.900	
High Int.	17:15									17:15				17:00				
Volume	60	185	0	245	0	0	0	0	0	114	93	207	10	0	58	68		
Peak Factor				0.902								0.871				0.890		

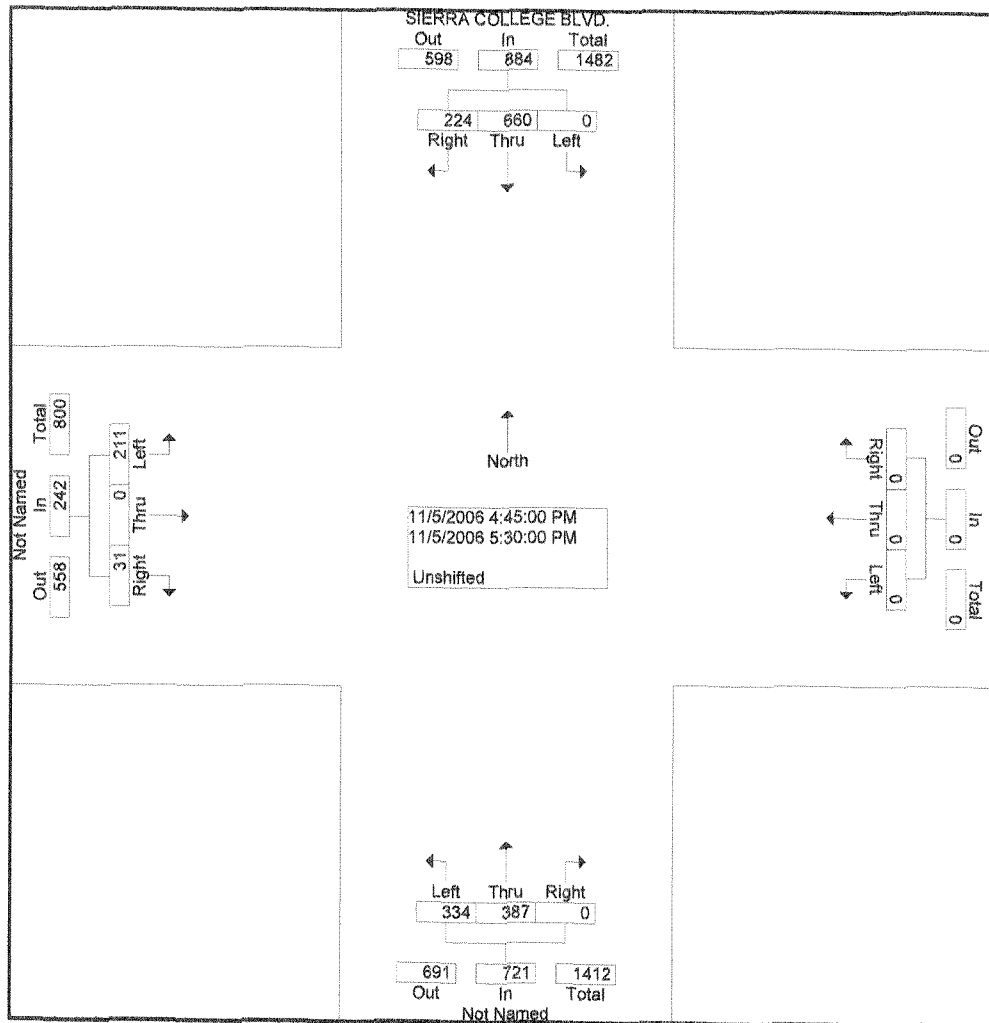

Intersection Turning Movement

Prepared by: Southland Car Counters

N-S STREET: Sierra College Blvd.

DATE: 08/19/2006

LOCATION: City of Rocklin

E-W STREET: I-80 NB Ramp

DAY: SATURDAY

PROJECT# 06-7188-002

LANES:	NORTHBOUND			SOUTHBOUND			EASTBOUND			WESTBOUND			TOTAL
	NL	NT	NR	SL	ST	SR	EL	ET	ER	WL	WT	WR	
	1	1			1	0	1			1			
10:00 AM													
10:15 AM													
10:30 AM													
10:45 AM													
11:00 AM	26	74		1	79	6	36			27			249
11:15 AM	32	89		0	93	9	41			33			297
11:30 AM	40	83		3	116	6	53			38			339
11:45 AM	34	70		0	76	4	58			29			271
12:00 PM	38	77		1	88	14	65			38			321
12:15 PM	33	66		4	101	18	58			44			324
12:30 PM	37	69		2	93	25	50			42			318
12:45 PM	43	78		1	125	21	74			68			410
1:00 PM													
1:15 PM													
1:30 PM													
1:45 PM													
2:00 PM													
2:15 PM													
2:30 PM													
2:45 PM													

TOTAL VOLUMES =	NL	NT	NR	SL	ST	SR	EL	ET	ER	WL	WT	WR	TOTAL
	283	606	0	12	771	103	435	0	319	0	0	0	2529

NOON Peak Hr Begins at: 1200 PM

Adjusted to existing SL lane

PEAK VOLUMES =	151	290	0	8	407	78	247	0	192	0	0	0	1373
PEAK HR. FACTOR:		0.911			0.838			0.773			0.000		0.837

CONTROL: Signalized

ALL TRAFFIC DATA INC.

(916)771-8700

FAX 786-2879

CITY OF ROCKLIN

File Name : F-Sierra College-Rocklin Rd 13
 Site Code : 00000000
 Start Date : 10/4/2006
 Page No : 1

Groups Printed- Unshifted

Start Time	SIERRA COLLEGE BLVD. Southbound				ROCKLIN RD. Westbound				Northbound				Eastbound				Int. Total
	Right	Thru	Left	App. Total	Right	Thru	Left	App. Total	Right	Thru	Left	App. Total	Right	Thru	Left	App. Total	
07:00	9	113	8	130	7	40	13	60	4	106	62	172	26	38	14	78	440
07:15	15	111	15	141	13	46	10	69	9	105	81	195	50	30	17	97	502
07:30	17	100	15	132	20	41	16	77	16	127	106	249	61	14	13	88	546
07:45	7	79	13	99	23	45	26	94	19	109	112	240	72	30	24	126	559
Total	48	403	51	502	63	172	65	300	48	447	361	856	209	112	68	389	2047
08:00	8	142	7	157	10	41	15	66	14	122	91	227	59	40	15	114	564
08:15	7	92	14	113	12	43	11	66	7	103	90	200	77	25	13	115	494
08:30	8	106	12	126	10	27	13	50	5	85	59	149	76	38	14	128	453
08:45	16	91	21	128	13	34	8	55	9	77	65	151	58	28	27	113	447
Total	39	431	54	524	45	145	47	237	35	387	305	727	270	131	69	470	1958
16:00	13	119	21	153	9	30	11	50	10	138	73	221	94	72	41	207	631
16:15	16	115	10	141	10	29	9	48	9	145	71	225	81	62	21	164	578
16:30	22	110	16	148	9	35	10	54	11	106	75	192	95	56	32	183	577
16:45	18	139	15	172	11	31	8	50	14	131	82	227	101	69	54	224	673
Total	69	483	62	614	39	125	38	202	44	520	301	865	371	259	148	778	2459
17:00	12	115	22	149	9	37	5	51	17	153	76	246	130	69	52	251	697
17:15	23	126	13	162	5	33	6	44	8	149	72	229	75	53	27	155	590
17:30	25	125	17	167	12	38	11	61	13	171	68	252	98	44	38	180	660
17:45	10	118	9	137	8	41	13	62	9	129	109	247	80	56	34	170	616
Total	70	484	61	615	34	149	35	218	47	602	325	974	383	222	151	756	2563
Grand Total	226	1801	228	2255	181	591	185	957	174	1956	1292	3422	1233	724	436	2393	9027
Apprch %	10.0	79.9	10.1		18.9	61.8	19.3		5.1	57.2	37.8		51.5	30.3	18.2		
Total %	2.5	20.0	2.5	25.0	2.0	6.5	2.0	10.6	1.9	21.7	14.3	37.9	13.7	8.0	4.8	26.5	

Start Time	SIERRA COLLEGE BLVD. Southbound				ROCKLIN RD. Westbound				Northbound				Eastbound				Int. Total
	Right	Thru	Left	App. Total	Right	Thru	Left	App. Total	Right	Thru	Left	App. Total	Right	Thru	Left	App. Total	
Peak Hour From 07:00 to 08:45 - Peak 1 of 1																	
Intersection 07:15																	
Volume	47	432	50	529	66	173	67	306	58	463	390	911	242	114	69	425	2171
Percent	8.9	81.7	9.5		21.6	56.5	21.9		6.4	50.8	42.8		56.9	26.8	16.2		
08:00 Volume	8	142	7	157	10	41	15	66	14	122	91	227	59	40	15	114	564
Peak Factor																	
High Int. 08:00																	
Volume	8	142	7	157	07:45 23	45	26	94	07:30 16	127	106	249	07:45 72	30	24	126	864
Peak Factor	0.842				0.814				0.915				0.843				

ALL TRAFFIC DATA INC.

(916)771-8700

FAX 786-2879

File Name : F-Sierra College-Rocklin Rd

Site Code : 00000000

Start Date : 10/4/2006

Page No : 2

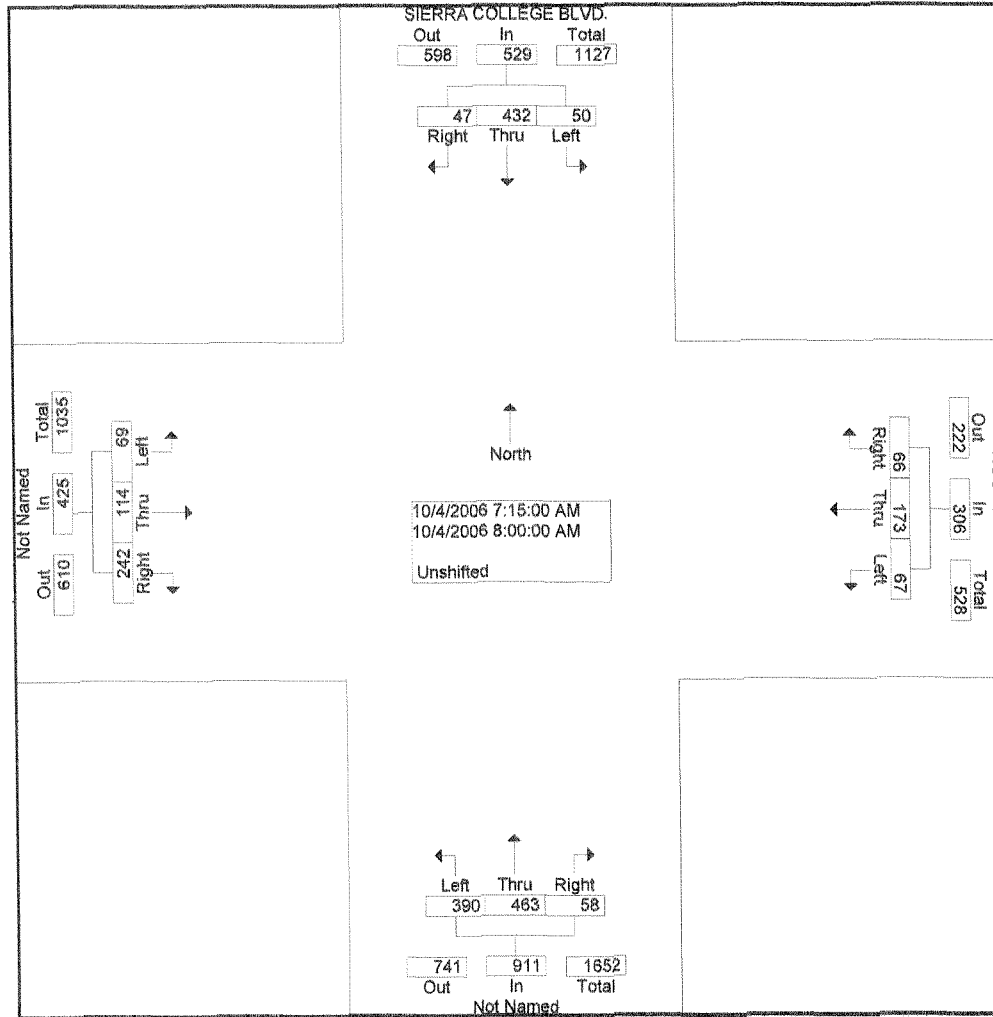

ALL TRAFFIC DATA INC.
(916)771-8700
FAX 786-2879

File Name : F-Sierra College-Rocklin Rd
 Site Code : 00000000
 Start Date : 10/4/2006
 Page No : 3

Start Time	SIERRA COLLEGE BLVD. Southbound				ROCKLIN RD. Westbound				Northbound				Eastbound				Int. Total
	Right	Thru	Left	App. Total	Right	Thru	Left	App. Total	Right	Thru	Left	App. Total	Right	Thru	Left	App. Total	
Peak Hour From 16:00 to 17:45 - Peak 1 of 1																	
Intersection	16:45																
Volume	78	505	67	650	37	139	30	206	52	604	298	954	404	235	171	810	2620
Percent	12.0	77.7	10.3		18.0	67.5	14.6		5.5	63.3	31.2		49.9	29.0	21.1		
17:00 Volume	12	115	22	149	9	37	5	51	17	153	76	246	130	69	52	251	697
Peak Factor	0.940																
High Int.	16:45				17:30				17:30				17:00				
Volume	18	139	15	172	12	38	11	61	13	171	68	252	130	69	52	251	
Peak Factor	0.945				0.844				0.946				0.807				

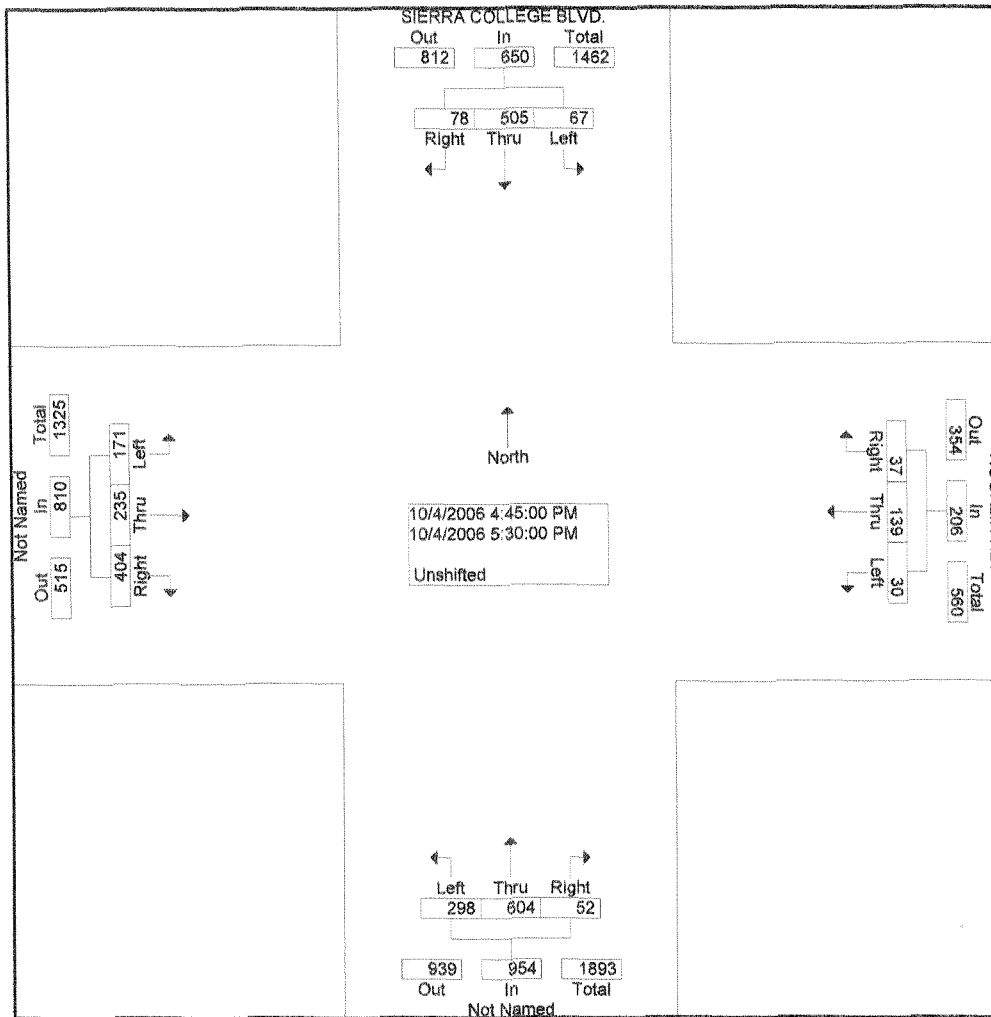

Intersection Turning Movement

Prepared by: Southland Car Counters

N-S STREET: Sierra College Blvd.

DATE: 08/26/2006

LOCATION: City of Rocklin

E-W STREET: Rocklin Rd.

DAY: SATURDAY

PROJECT# 06-7188-001

LANES:	NORTHBOUND			SOUTHBOUND			EASTBOUND			WESTBOUND			TOTAL
	NL 1	NT 2	NR 0	SL 1	ST 2	SR 0	EL 1	ET 2	ER 1	WL 1	WT 1	WR 0	
10:00 AM													
10:15 AM													
10:30 AM													
10:45 AM													
11:00 AM	42	61	4	5	72	31	31	27	53	7	42	13	388
11:15 AM	47	81	7	6	84	24	24	31	46	11	52	9	422
11:30 AM	43	103	11	9	78	13	20	39	41	9	42	7	415
11:45 AM	59	108	7	13	87	17	16	40	55	14	38	7	461
12:00 PM	54	84	9	11	79	14	24	42	46	10	35	2	410
12:15 PM	43	72	8	9	75	19	21	50	37	7	39	6	386
12:30 PM	46	79	7	12	72	13	20	42	30	11	35	13	380
12:45 PM	41	64	5	11	61	10	13	35	22	9	29	8	308
1:00 PM													
1:15 PM													
1:30 PM													
1:45 PM													
2:00 PM													
2:15 PM													
2:30 PM													
2:45 PM													

TOTAL VOLUMES =	NL	NT	NR	SL	ST	SR	EL	ET	ER	WL	WT	WR	TOTAL
	375	652	58	76	608	141	169	306	330	78	312	65	3170

NOON Peak Hr Begins at: 1115 AM

PEAK VOLUMES =	NL	NT	NR	SL	ST	SR	EL	ET	ER	WL	WT	WR	TOTAL
	203	376	34	39	328	68	84	152	188	44	167	25	1708
PEAK HR. FACTOR:		0.881			0.929			0.946			0.819		0.926

CONTROL: Signalized

ALL TRAFFIC DATA INC.

(916)771-8700

FAX 786-2879

CITY OF ROCKLIN

File Name : F-Horseshoe Bar-Taylor Rd.
 Site Code : 00000000
 Start Date : 11/10/2006
 Page No : 1

14

Groups Printed- Unshifted

Start Time	HORSESHOE BAR RD. Southbound				TAYLOR RD. Westbound				Northbound				Eastbound				Int. Total
	Right	Thru	Left	App. Total	Right	Thru	Left	App. Total	Right	Thru	Left	App. Total	Right	Thru	Left	App. Total	
07:00	1	1	1	3	0	62	94	156	104	4	6	114	12	57	0	69	342
07:15	4	11	6	21	0	64	103	167	133	2	8	143	17	83	3	103	434
07:30	6	31	0	37	2	123	118	243	111	4	8	123	22	67	1	90	493
07:45	10	20	3	33	3	91	136	230	85	4	12	101	13	55	1	69	433
Total	21	63	10	94	5	340	451	796	433	14	34	481	64	262	5	331	1702
08:00	2	5	5	12	1	81	100	182	77	4	17	98	14	64	1	79	371
08:15	2	2	1	5	4	79	93	176	91	2	15	108	13	60	1	74	363
08:30	5	3	0	8	3	68	73	144	53	3	12	68	20	61	1	82	302
08:45	0	5	0	5	3	72	71	146	69	0	8	77	15	43	1	59	287
Total	9	15	6	30	11	300	337	648	290	9	52	351	62	228	4	294	1323
16:00	2	1	2	5	0	86	98	184	126	4	29	159	30	126	3	159	507
16:15	1	2	5	8	2	102	93	197	135	3	17	155	26	116	0	142	502
16:30	4	5	1	10	1	115	99	215	127	3	22	152	26	122	3	151	528
16:45	2	3	1	6	3	99	94	196	135	4	17	156	32	106	0	138	496
Total	9	11	9	29	6	402	384	792	523	14	85	622	114	470	6	590	2033
17:00	2	3	3	8	2	104	109	215	144	2	14	160	28	115	2	145	528
17:15	0	1	2	3	4	91	107	202	166	4	24	194	18	133	3	154	553
17:30	0	4	5	9	5	93	110	208	150	6	24	180	28	94	5	127	524
17:45	2	6	3	11	7	85	96	188	139	6	15	160	28	100	2	130	489
Total	4	14	13	31	18	373	422	813	599	18	77	694	102	442	12	556	2094
Grand Total	43	103	38	184	40	1415	1594	3049	1845	55	248	2148	342	1402	27	1771	7152
Apprch %	23.4	56.0	20.7		1.3	46.4	52.3		85.9	2.6	11.5		19.3	79.2	1.5		
Total %	0.6	1.4	0.5	2.6	0.6	19.8	22.3	42.6	25.8	0.8	3.5	30.0	4.8	19.6	0.4	24.8	

Start Time	HORSESHOE BAR RD. Southbound				TAYLOR RD. Westbound				Northbound				Eastbound				Int. Total
	Right	Thru	Left	App. Total	Right	Thru	Left	App. Total	Right	Thru	Left	App. Total	Right	Thru	Left	App. Total	
Peak Hour From 07:00 to 08:45 - Peak 1 of 1																	
Intersection	07:15																
Volume	22	67	14	103	6	359	457	822	406	14	45	465	66	269	6	341	1731
Percent	21.4	65.0	13.6		0.7	43.7	55.6		87.3	3.0	9.7		19.4	78.9	1.8		
07:30 Volume	6	31	0	37	2	123	118	243	111	4	8	123	22	67	1	90	493
Peak Factor																	0.878
High Int.	07:30				07:30				07:15				07:15				
Volume	6	31	0	37	2	123	118	243	133	2	8	143	17	83	3	103	
Peak Factor				0.696				0.846				0.813				0.828	

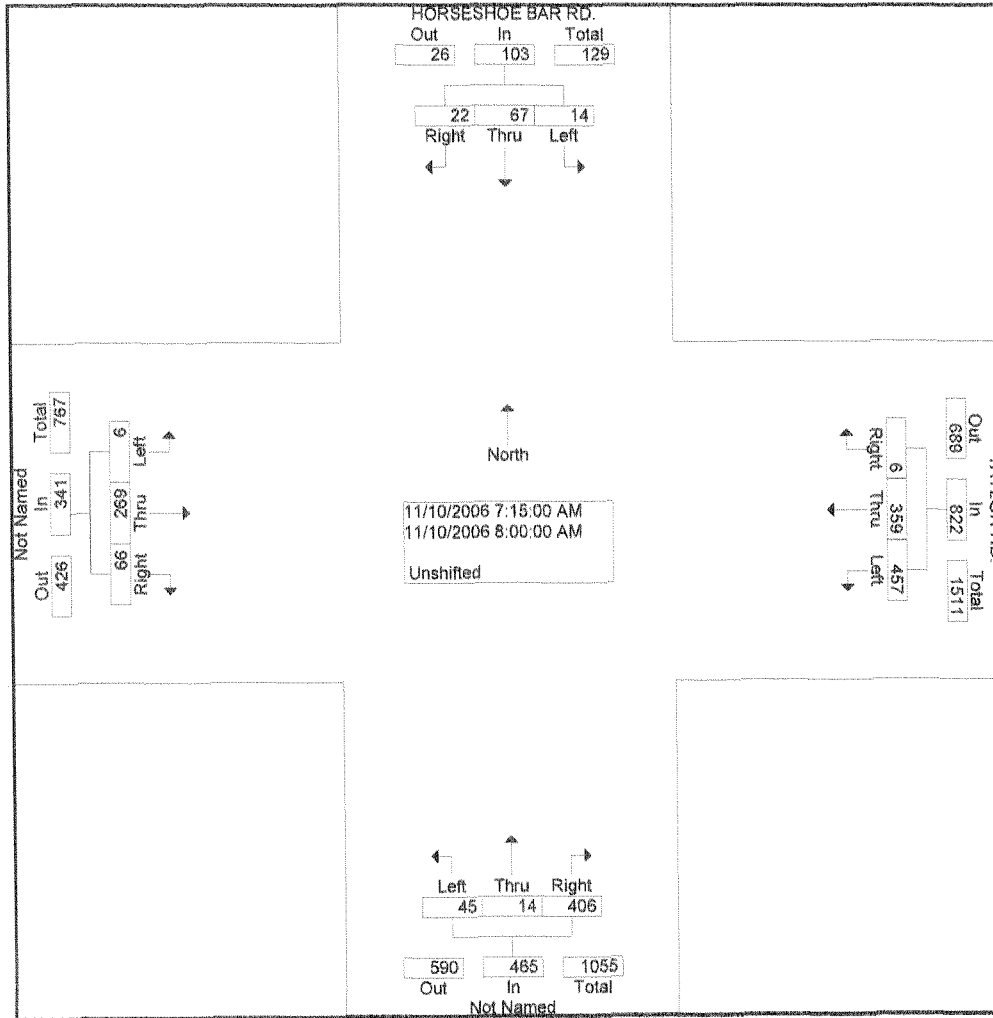

ALL TRAFFIC DATA INC.
(916)771-8700
FAX 786-2879

File Name : F-Horseshoe Bar-Taylor Rd.
 Site Code : 00000000
 Start Date : 11/10/2006
 Page No : 3

Start Time	HORSESHOE BAR RD. Southbound				TAYLOR RD. Westbound				Northbound				Eastbound				Int. Total
	Right	Thru	Left	App. Total	Right	Thru	Left	App. Total	Right	Thru	Left	App. Total	Right	Thru	Left	App. Total	
Peak Hour From 16:00 to 17:45 - Peak 1 of 1																	
Intersection	16:30																
Volume	8	12	7	27	10	409	409	828	572	13	77	662	104	476	8	588	2105
Percent	29.6	44.4	25.9		1.2	49.4	49.4		86.4	2.0	11.6		17.7	81.0	1.4		
17:15 Volume	0	1	2	3	4	91	107	202	166	4	24	194	18	133	3	154	553
Peak Factor																	0.952
High Int.	16:30				16:30				17:15				17:15				
Volume	4	5	1	10	1	115	99	215	166	4	24	194	18	133	3	154	
Peak Factor				0.675				0.963				0.853				0.955	

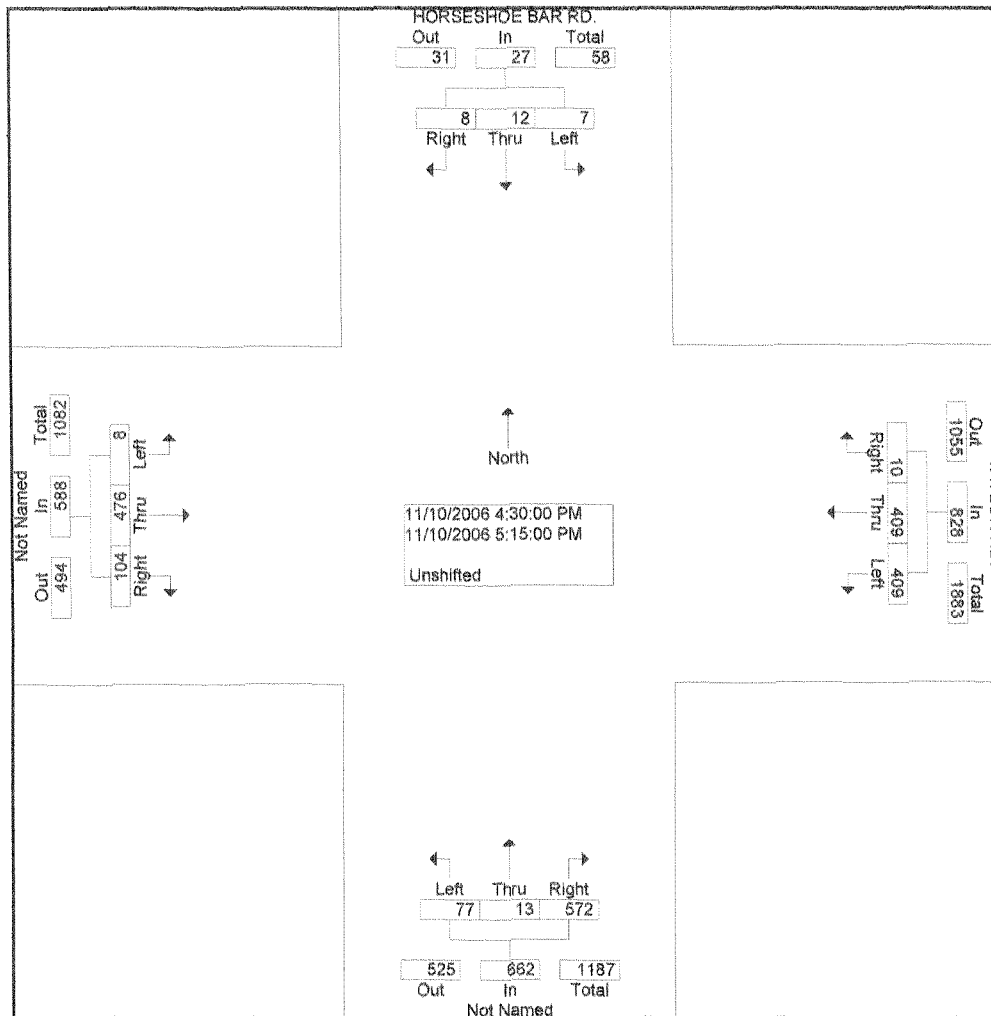

Intersection Turning Movement

Prepared by: Southland Car Counters

N-S STREET: Taylor Rd.

DATE: 08/19/2006

LOCATION: City of Rocklin

E-W STREET: Horseshoe Bar Rd.

DAY: SATURDAY

PROJECT# 06-7188-012

LANES:	NORTHBOUND			SOUTHBOUND			EASTBOUND			WESTBOUND			TOTAL
	NL	NT	NR	SL	ST	SR	EL	ET	ER	WL	WT	WR	
	.5	.5	1	0	1	0	1	1	0	1	1	0	
10:00 AM													
10:15 AM													
10:30 AM													
10:45 AM													
11:00 AM	2	67	29	79	77	3	0	1	3	21	3	61	346
11:15 AM	3	75	35	85	86	4	1	1	1	27	6	68	392
11:30 AM	1	80	26	59	72	1	1	2	0	17	3	79	341
11:45 AM	4	89	36	68	64	2	3	3	2	19	4	84	378
12:00 PM	3	84	30	67	88	1	0	3	1	23	5	63	368
12:15 PM	5	79	19	79	83	2	2	4	4	29	2	52	360
12:30 PM	2	81	14	86	77	1	1	6	1	31	1	74	375
12:45 PM	2	65	26	81	69	3	4	2	2	17	4	67	342
1:00 PM													
1:15 PM													
1:30 PM													
1:45 PM													
2:00 PM													
2:15 PM													
2:30 PM													
2:45 PM													

TOTAL VOLUMES =	NL	NT	NR	SL	ST	SR	EL	ET	ER	WL	WT	WR	TOTAL
	22	620	215	604	616	17	12	22	14	184	28	548	2902

NOON Peak Hr Begins at: 1145 AM

PEAK VOLUMES =	14	333	99	300	312	6	6	16	8	102	12	273	1481
PEAK HR. FACTOR:		0.864		0.942			0.750			0.904			0.979

CONTROL: Signalized

ALL TRAFFIC DATA INC.

(916)771-8700

FAX 786-2879

CITY OF ROCKLIN

File Name : F-horseshoe bar (180sb) ramps
 Site Code : 00000000
 Start Date : 10/5/2006
 Page No : 1

WB
 15

Groups Printed- Unshifted

Start Time	HORSESHOE BAR RD. Southbound				180 WB RAMPS Westbound				Northbound				Eastbound				Int. Total
	Right	Thru	Left	App. Total	Right	Thru	Left	App. Total	Right	Thru	Left	App. Total	Right	Thru	Left	App. Total	
07:00	89	30	4	123	6	11	7	24	15	112	22	149	8	9	18	35	331
07:15	87	41	3	131	8	13	9	30	19	119	35	173	15	9	13	37	371
07:30	121	80	4	205	6	29	9	44	11	117	41	169	21	9	17	47	465
07:45	121	69	7	197	9	18	9	36	23	92	55	170	26	7	22	55	458
Total	418	220	18	656	29	71	34	134	68	440	153	661	70	34	70	174	1625
08:00	90	43	3	136	7	20	12	39	15	105	31	151	14	8	22	44	370
08:15	90	52	6	148	12	11	6	29	22	89	42	153	11	8	18	37	367
08:30	86	23	6	115	16	12	12	40	10	65	38	113	11	12	15	38	306
08:45	54	30	3	87	5	12	6	23	6	53	24	83	8	10	19	37	230
Total	320	148	18	486	40	55	36	131	53	312	135	500	44	38	74	156	1273
16:00	91	47	16	154	25	14	42	81	34	98	11	143	12	10	20	42	420
16:15	58	51	10	119	16	7	37	60	43	99	25	167	14	8	18	40	386
16:30	97	55	11	163	20	12	37	69	43	94	27	164	19	17	18	54	450
16:45	79	48	12	139	16	14	25	55	44	95	25	164	18	15	29	62	420
Total	325	201	49	575	77	47	141	265	164	386	88	638	63	50	85	198	1676
17:00	122	61	13	196	18	15	30	63	47	95	22	164	12	2	13	27	450
17:15	89	38	12	139	18	9	48	75	43	89	14	146	18	12	15	45	405
17:30	72	33	16	121	32	8	36	76	54	97	35	186	8	10	19	37	420
17:45	64	42	11	117	15	6	25	46	45	89	28	162	14	12	16	42	367
Total	347	174	52	573	83	38	139	260	189	370	99	658	52	36	63	151	1642
Grand Total	1410	743	137	2290	229	211	350	790	474	1508	475	2457	229	158	292	679	6216
Approch %	61.6	32.4	6.0		29.0	26.7	44.3		19.3	61.4	19.3		33.7	23.3	43.0		
Total %	22.7	12.0	2.2	36.8	3.7	3.4	5.6	12.7	7.6	24.3	7.6	39.5	3.7	2.5	4.7	10.9	

Start Time	HORSESHOE BAR RD. Southbound				180 WB RAMPS Westbound				Northbound				Eastbound				Int. Total
	Right	Thru	Left	App. Total	Right	Thru	Left	App. Total	Right	Thru	Left	App. Total	Right	Thru	Left	App. Total	
Peak Hour From 07:00 to 08:45 - Peak 1 of 1																	
Intersection	07:15																
Volume	419	233	17	669	30	80	39	149	68	433	162	663	76	33	74	183	1664
Percent	62.6	34.8	2.5		20.1	53.7	26.2		10.3	65.3	24.4		41.5	18.0	40.4		
07:30 Volume	121	80	4	205	6	29	9	44	11	117	41	169	21	9	17	47	465
Peak Factor																	0.895
High Int.	07:30				07:30				07:15				07:45				
Volume	121	80	4	205	6	29	9	44	19	119	35	173	26	7	22	55	
Peak Factor	0.816				0.847				0.958				0.832				

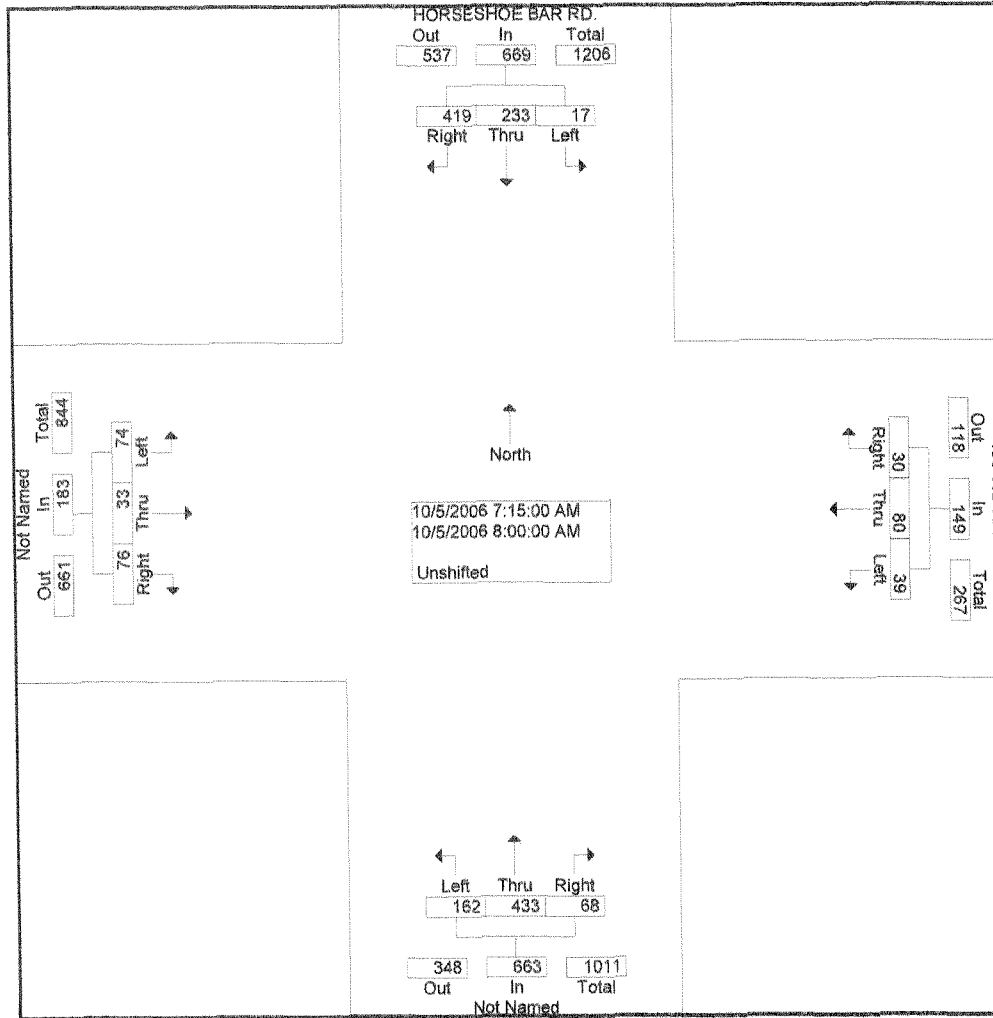

ALL TRAFFIC DATA INC.
(916)771-8700
FAX 786-2879

File Name : F-horseshoe bar-180sb ramps
 Site Code : 00000000
 Start Date : 10/5/2006
 Page No : 3

Start Time	HORSESHOE BAR RD. Southbound				180 WB RAMPS Westbound				Northbound				Eastbound				Int. Total
	Right	Thru	Left	App. Total	Right	Thru	Left	App. Total	Right	Thru	Left	App. Total	Right	Thru	Left	App. Total	
Peak Hour From 16:00 to 17:45 - Peak 1 of 1																	
Intersection	16:30																
Volume	387	202	48	637	72	50	140	262	177	373	88	638	67	46	75	188	1725
Percent	60.8	31.7	7.5		27.5	19.1	53.4		27.7	58.5	13.8		35.6	24.5	39.9		
17:00 Volume	122	61	13	196	18	15	30	63	47	95	22	164	12	2	13	27	450
Peak Factor	0.958																
High Int.	17:00																
Volume	122	61	13	196	18	9	48	75	43	94	27	164	18	15	29	62	
Peak Factor	0.813				0.873				0.973				0.758				

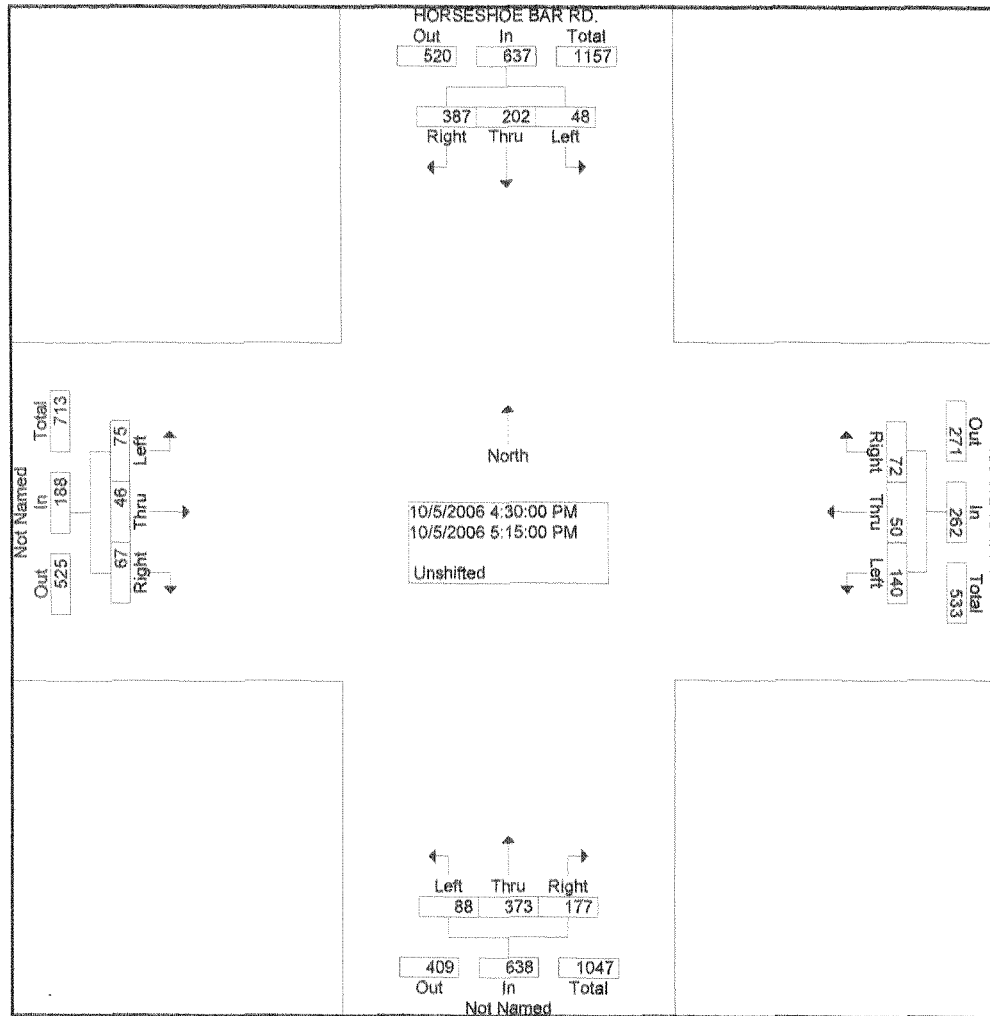

Intersection Turning Movement

Prepared by: Southland Car Counters

N-S STREET: I-80 SB Ramps

DATE: 08/19/2006

LOCATION: City of Rocklin

E-W STREET: Horseshoe Bar Rd.

DAY: SATURDAY

PROJECT# 06-7188-013

LANES:	NORTHBOUND			SOUTHBOUND			EASTBOUND			WESTBOUND			TOTAL
	NL 1	NT 2	NR 0	SL 1	ST 1	SR 1	EL .5	ET .5	ER 1	WL .5	WT .5	WR 1	
10:00 AM													
10:15 AM													
10:30 AM													
10:45 AM													
11:00 AM	10	12	11	16	2	10	8	19	24	29	53	12	206
11:15 AM	8	15	6	23	4	16	7	28	31	31	68	17	254
11:30 AM	11	13	7	34	5	18	11	35	35	37	77	27	310
11:45 AM	14	11	8	37	13	12	12	44	50	25	67	17	310
12:00 PM	12	7	8	34	12	14	14	50	42	29	78	28	328
12:15 PM	13	13	13	25	15	18	8	35	51	22	64	19	296
12:30 PM	9	12	10	29	18	16	6	43	59	27	79	16	324
12:45 PM	24	9	6	14	14	14	9	24	33	13	57	13	230
1:00 PM													
1:15 PM													
1:30 PM													
1:45 PM													
2:00 PM													
2:15 PM													
2:30 PM													
2:45 PM													

TOTAL VOLUMES =	NL 101	NT 92	NR 69	SL 212	ST 83	SR 118	EL 75	ET 278	ER 325	WL 213	WT 543	WR 149	TOTAL 2258
-----------------	-----------	----------	----------	-----------	----------	-----------	----------	-----------	-----------	-----------	-----------	-----------	---------------

NOON Peak Hr Begins at: 1145 AM

PEAK VOLUMES =	48	43	39	125	58	60	40	172	202	103	288	80	1258
PEAK HR. FACTOR:		0.833		0.964				0.958			0.872		0.959

CONTROL: Signalized

ALL TRAFFIC DATA INC.
(916)771-8700
FAX 786-2879

CITY OF ROCKLIN

File Name : F-Horseshoe Bar-180 EB Ramps
 Site Code : 00000000
 Start Date : 10/5/2006
 Page No : 1

18

Groups Printed- Unshifted

Start Time	HORSESHOE BAR RD. Southbound				180 EB RAMPS Westbound				Northbound				Eastbound				Int. Total
	Right	Thru	Left	App. Total	Right	Thru	Left	App. Total	Right	Thru	Left	App. Total	Right	Thru	Left	App. Total	
07:00	0	36	16	52	89	0	9	98	10	58	0	68	0	0	0	0	218
07:15	0	49	13	62	94	0	15	109	11	88	0	99	0	0	0	0	270
07:30	0	69	38	107	73	0	16	89	14	92	0	106	0	0	0	0	302
07:45	0	72	34	106	65	0	13	78	15	102	0	117	0	0	0	0	301
Total	0	226	101	327	321	0	53	374	50	340	0	390	0	0	0	0	1091
08:00	0	55	13	68	80	0	11	91	10	71	0	81	0	0	0	0	240
08:15	0	41	27	68	68	0	16	84	10	88	0	98	0	0	0	0	250
08:30	0	37	10	47	55	0	12	67	14	57	0	71	0	0	0	0	185
08:45	0	27	16	43	50	0	14	64	4	45	0	49	0	0	0	0	156
Total	0	160	66	226	253	0	53	306	38	261	0	299	0	0	0	0	831
16:00	0	58	43	101	86	0	21	107	13	48	0	61	0	0	0	0	269
16:15	0	65	39	104	109	0	29	138	13	77	0	90	0	0	0	0	332
16:30	0	63	49	112	96	0	30	126	13	70	0	83	0	0	0	0	321
16:45	0	56	27	83	91	0	24	115	14	63	0	77	0	0	0	0	275
Total	0	242	158	400	382	0	104	486	53	258	0	311	0	0	0	0	1197
17:00	0	58	42	100	102	0	31	133	21	63	0	84	0	0	0	0	317
17:15	0	58	44	102	91	0	31	122	14	63	0	77	0	0	0	0	301
17:30	0	50	29	79	127	0	36	163	9	61	0	70	0	0	0	0	312
17:45	0	57	27	84	95	0	39	134	14	52	0	66	0	0	0	0	284
Total	0	223	142	365	415	0	137	552	58	239	0	297	0	0	0	0	1214
Grand Total	0	851	467	1318	1371	0	347	1718	199	1098	0	1297	0	0	0	0	4333
Apprch %	0.0	64.6	35.4		79.8	0.0	20.2		15.3	84.7	0.0		0.0	0.0	0.0		
Total %	0.0	19.6	10.8	30.4	31.6	0.0	8.0	39.6	4.6	25.3	0.0	29.9	0.0	0.0	0.0	0.0	

Start Time	HORSESHOE BAR RD. Southbound				180 EB RAMPS Westbound				Northbound				Eastbound				Int. Total	
	Right	Thru	Left	App. Total	Right	Thru	Left	App. Total	Right	Thru	Left	App. Total	Right	Thru	Left	App. Total		
Peak Hour From 07:00 to 08:45 - Peak 1 of 1																		
Intersection	07:15																	
Volume	0	245	98	343	312	0	55	367	50	353	0	403	0	0	0	0	1113	
Percent	0.0	71.4	28.6		85.0	0.0	15.0		12.4	87.6	0.0		0.0	0.0	0.0			
07:30 Volume	0	69	38	107	73	0	16	89	14	92	0	106	0	0	0	0	302	
Peak Factor	0.921																	
High Int.	07:30																	
Volume	0	69	38	107	07:15	94	0	15	109	07:45	15	102	0	117	6:45:00 AM			
Peak Factor	0.801				0.842				0.861									

ALL TRAFFIC DATA INC.

(916)771-8700

FAX 786-2879

File Name : F-Horseshoe Bar-180 EB Ramps

Site Code : 00000000

Start Date : 10/5/2006

Page No : 2

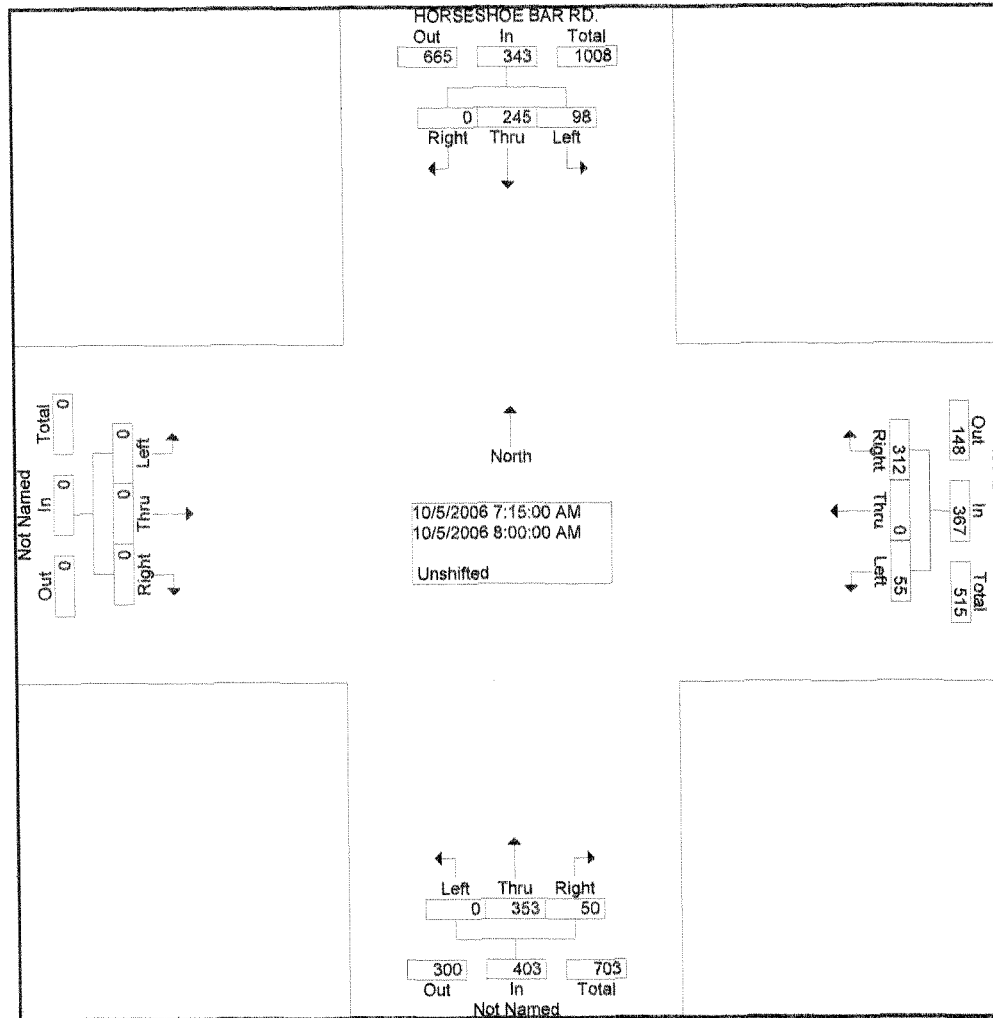

ALL TRAFFIC DATA INC.

(916)771-8700

FAX 786-2879

File Name : F-Horseshoe Bar-I80 EB Ramps

Site Code : 00000000

Start Date : 10/5/2006

Page No : 3

Start Time	HORSESHOE BAR RD. Southbound				I80 EB RAMPS Westbound				Northbound				Eastbound				Int. Total	
	Right	Thru	Left	App. Total	Right	Thru	Left	App. Total	Right	Thru	Left	App. Total	Right	Thru	Left	App. Total		
Peak Hour From 16:00 to 17:45 - Peak 1 of 1																		
Intersection	16:15																	
Volume	0	242	157	399	398	0	114	512	61	273	0	334	0	0	0	0	0	1245
Percent	0.0	60.7	39.3		77.7	0.0	22.3		18.3	81.7	0.0		0.0	0.0	0.0			
16:15 Volume	0	65	39	104	109	0	29	138	13	77	0	90	0	0	0	0	0	332
Peak Factor	0.938																	
High Int.	16:30																	
Volume	0	63	49	112	109	0	29	138	13	77	0	90						
Peak Factor	0.891				0.928				0.928									

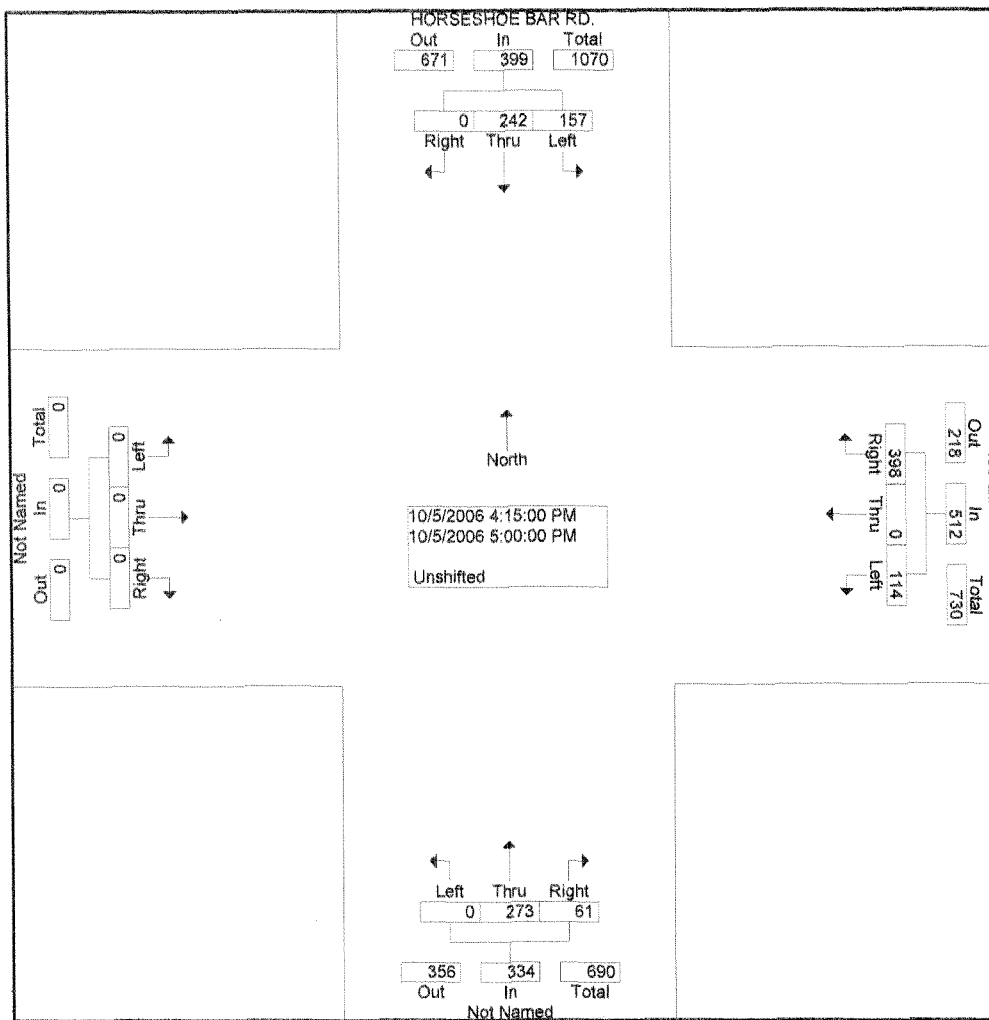

Intersection Turning Movement

Prepared by: Southland Car Counters

N-S STREET: I-80 NB Ramps

DATE: 08/19/2006

LOCATION: City of Rocklin

E-W STREET: Horseshoe Bar Rd.

DAY: SATURDAY

PROJECT# 06-7188-014

LANES:	NORTHBOUND			SOUTHBOUND			EASTBOUND			WESTBOUND			TOTAL
	NL	NT	NR	SL	ST	SR	EL	ET	ER	WL	WT	WR	
	0	1	0	0	1	0	0	0	0	0	1	0	
10:00 AM													
10:15 AM													
10:30 AM													
10:45 AM													
11:00 AM				18		48	15	30			48	7	166
11:15 AM				13		65	18	38			62	3	199
11:30 AM				16		53	19	45			73	5	211
11:45 AM				11		60	25	62			59	8	225
12:00 PM				9		49	31	57			72	9	227
12:15 PM				14		52	18	59			61	12	216
12:30 PM				12		45	14	78			65	16	230
12:45 PM				8		39	11	47			58	22	185
1:00 PM													
1:15 PM													
1:30 PM													
1:45 PM													
2:00 PM													
2:15 PM													
2:30 PM													
2:45 PM													

TOTAL VOLUMES =	NL	NT	NR	SL	ST	SR	EL	ET	ER	WL	WT	WR	TOTAL
	0	0	0	101	0	411	151	416	0	0	498	82	1659

NOON Peak Hr Begins at: 1145 AM

PEAK VOLUMES =	0	0	0	46	0	206	88	256	0	0	257	45	898
PEAK HR. FACTOR:		0.000			0.887			0.000			0.932		0.976

CONTROL: 1 Way Stop

ALL TRAFFIC DATA INC.

(916)771-8700

FAX 786-2879

CITY OF ROCKLIN

File Name : F-Barton-Brace
 Site Code : 00000000
 Start Date : 10/5/2006
 Page No : 1

17

Groups Printed- Unshifted

Start Time	BARTON RD. Southbound				BRACE RD. Westbound				Northbound				Eastbound				Int. Total
	Right	Thru	Left	App. Total	Right	Thru	Left	App. Total	Right	Thru	Left	App. Total	Right	Thru	Left	App. Total	
07:00	0	0	0	0	0	6	14	20	11	0	10	21	11	1	0	12	53
07:15	0	0	0	0	0	10	33	43	31	0	29	60	35	6	0	41	144
07:30	0	0	0	0	0	15	36	51	55	0	30	85	25	17	0	42	178
07:45	0	0	0	0	0	31	25	56	43	0	35	78	21	10	0	31	165
Total	0	0	0	0	0	62	108	170	140	0	104	244	92	34	0	126	540
08:00	0	0	0	0	0	52	22	74	33	0	43	76	30	18	0	48	198
08:15	0	0	0	0	0	12	22	34	24	0	25	49	48	34	0	82	165
08:30	0	0	0	0	0	6	11	17	21	0	20	41	25	14	0	39	97
08:45	0	0	0	0	0	13	15	28	34	0	9	43	15	7	0	22	93
Total	0	0	0	0	0	83	70	153	112	0	97	209	118	73	0	191	553
16:00	0	0	0	0	0	15	33	48	15	0	38	53	34	13	0	47	148
16:15	0	0	0	0	0	18	28	46	17	0	39	56	45	13	0	58	160
16:30	0	0	0	0	0	12	28	40	21	0	39	60	40	27	0	67	167
16:45	0	0	0	0	0	12	25	37	19	0	27	46	31	11	0	42	125
Total	0	0	0	0	0	57	114	171	72	0	143	215	150	64	0	214	600
17:00	0	0	0	0	0	15	27	42	23	0	22	45	26	15	0	41	128
17:15	0	0	0	0	0	13	34	47	36	0	25	61	23	13	0	36	144
17:30	0	0	0	0	0	10	34	44	23	0	24	47	28	14	0	42	133
17:45	0	0	0	0	0	10	22	32	30	0	21	51	22	8	0	30	113
Total	0	0	0	0	0	48	117	165	112	0	92	204	99	50	0	149	518
Grand Total	0	0	0	0	0	250	409	659	436	0	436	872	459	221	0	680	2211
Apprch %	0.0	0.0	0.0		0.0	37.9	62.1		50.0	0.0	50.0		67.5	32.5	0.0		
Total %	0.0	0.0	0.0	0.0	0.0	11.3	18.5	29.8	19.7	0.0	19.7	39.4	20.8	10.0	0.0	30.8	

Start Time	BARTON RD. Southbound				BRACE RD. Westbound				Northbound				Eastbound				Int. Total	
	Right	Thru	Left	App. Total	Right	Thru	Left	App. Total	Right	Thru	Left	App. Total	Right	Thru	Left	App. Total		
Peak Hour From 07:00 to 08:45 - Peak 1 of 1																		
Intersection	07:30																	
Volume	0	0	0	0	0	110	105	215	155	0	133	288	124	79	0	203	706	
Percent	0.0	0.0	0.0		0.0	51.2	48.8		53.8	0.0	46.2		61.1	38.9	0.0			
08:00 Volume	0	0	0	0	0	52	22	74	33	0	43	76	30	18	0	48	198	
Peak Factor																		0.891
High Int.	6:45:00 AM				08:00				07:30				08:15					
Volume	0	0	0	0	0	52	22	74	55	0	30	85	48	34	0	82		
Peak Factor																		0.619
																	0.726	
																	0.847	

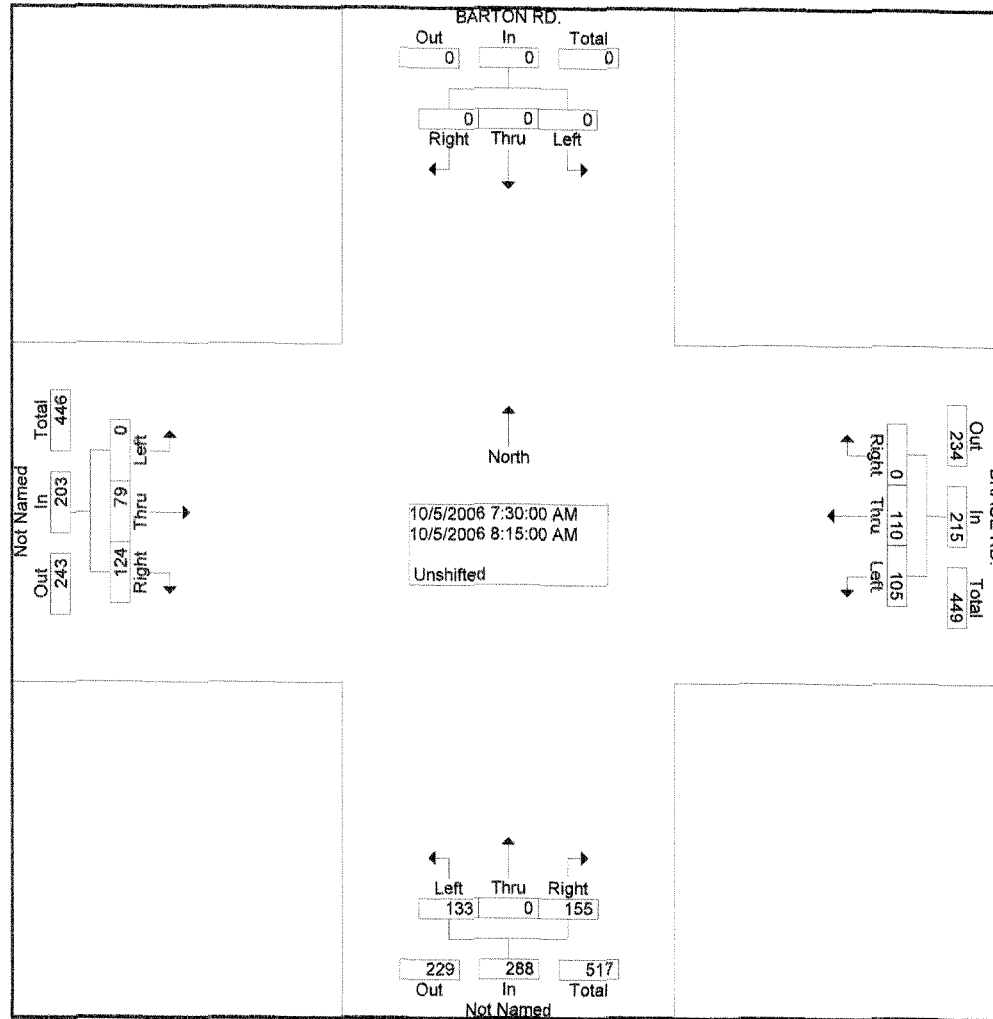

Intersection Turning Movement

Prepared by: Southland Car Counters

N-S STREET: Barton Rd

DATE: 08/19/2006

LOCATION: City of Rocklin

E-W STREET: Brace Rd

DAY: SATURDAY

PROJECT# 06-7188-015

LANES:	NORTHBOUND			SOUTHBOUND			EASTBOUND			WESTBOUND			TOTAL
	NL	NT	NR	SL	ST	SR	EL	ET	ER	WL	WT	WR	
	0	1	0	0	0	0	0	1	0	0	1	0	
10:00 AM													
10:15 AM													
10:30 AM													
10:45 AM													
11:00 AM	2		14					11	1	7	17		52
11:15 AM	1		16					15	5	19	11		67
11:30 AM	4		11					9	3	16	14		57
11:45 AM	3		16					18	4	26	9		76
12:00 PM	7		18					11	2	21	8		67
12:15 PM	4		26					12	6	19	14		81
12:30 PM	7		21					13	4	11	15		71
12:45 PM	4		25					16	9	9	19		82
1:00 PM													
1:15 PM													
1:30 PM													
1:45 PM													
2:00 PM													
2:15 PM													
2:30 PM													
2:45 PM													

TOTAL VOLUMES =	NL	NT	NR	SL	ST	SR	EL	ET	ER	WL	WT	WR	TOTAL
	32	0	147	0	0	0	0	105	34	128	107	0	553

NOON Peak Hr Begins at: 1200 PM

PEAK VOLUMES =	22	0	90	0	0	0	0	52	21	60	56	0	301
PEAK HR. FACTOR:	0.933		0.000			0.730			0.000			0.918	

CONTROL: One-Way Stop

ALL TRAFFIC DATA INC.

(916)771-8700

FAX 786-2879

CITY OF ROCKLIN

File Name : F-Barton-Rocklin

Site Code : 00000000

Start Date : 10/4/2006

Page No : 1

18

Groups Printed- Unshifted

Start Time	BARTON RD. Southbound				ROCKLIN RD. Westbound				Northbound				Eastbound				Int. Total
	Right	Thru	Left	App. Total	Right	Thru	Left	App. Total	Right	Thru	Left	App. Total	Right	Thru	Left	App. Total	
07:00	10	9	0	19	0	0	0	0	0	14	39	53	30	0	12	42	114
07:15	17	10	0	27	0	0	0	0	0	16	41	57	32	0	19	51	135
07:30	24	17	0	41	0	0	0	0	0	17	67	84	23	0	11	34	159
07:45	32	22	0	54	0	0	0	0	0	13	80	93	18	0	20	38	185
Total	83	58	0	141	0	0	0	0	0	60	227	287	103	0	62	165	593
08:00	19	14	0	33	0	0	0	0	0	13	42	55	28	0	35	63	151
08:15	23	19	0	42	0	0	0	0	0	12	51	63	18	0	17	35	140
08:30	18	15	0	33	0	0	0	0	0	9	33	42	25	0	12	37	112
08:45	13	12	0	25	0	0	0	0	0	11	34	45	26	0	21	47	117
Total	73	60	0	133	0	0	0	0	0	45	160	205	97	0	85	182	520
16:00	11	10	0	21	0	0	0	0	0	8	30	38	59	0	15	74	133
16:15	15	6	0	21	0	0	0	0	0	14	42	56	53	0	13	66	143
16:30	18	13	0	31	0	0	0	0	0	11	39	50	51	0	13	64	145
16:45	13	12	0	25	0	0	0	0	0	23	41	64	50	0	15	65	154
Total	57	41	0	98	0	0	0	0	0	56	152	208	213	0	56	269	575
17:00	9	12	0	21	0	0	0	0	0	20	31	51	88	0	20	108	180
17:15	17	12	0	29	0	0	0	0	0	11	26	37	48	0	9	57	123
17:30	13	17	0	30	0	0	0	0	0	12	50	62	45	0	12	57	149
17:45	12	12	0	24	0	0	0	0	0	13	47	60	44	0	13	57	141
Total	51	53	0	104	0	0	0	0	0	56	154	210	225	0	54	279	593
Grand Total	264	212	0	476	0	0	0	0	0	217	693	910	638	0	257	895	2281
Approch %	55.5	44.5	0.0		0.0	0.0	0.0		0.0	23.8	76.2		71.3	0.0	28.7		
Total %	11.6	9.3	0.0	20.9	0.0	0.0	0.0	0.0	0.0	9.5	30.4	39.9	28.0	0.0	11.3	39.2	

Start Time	BARTON RD. Southbound				ROCKLIN RD. Westbound				Northbound				Eastbound				Int. Total	
	Right	Thru	Left	App. Total	Right	Thru	Left	App. Total	Right	Thru	Left	App. Total	Right	Thru	Left	App. Total		
Peak Hour From 07:00 to 08:45 - Peak 1 of 1																		
Intersection 07:30																		
Volume	98	72	0	170	0	0	0	0	0	55	240	295	87	0	83	170	635	
Percent	57.6	42.4	0.0		0.0	0.0	0.0		0.0	18.6	81.4		51.2	0.0	48.8			
07:45 Volume	32	22	0	54	0	0	0	0	0	13	80	93	18	0	20	38	185	
Peak Factor																		
High Int. 07:45																		
Volume	32	22	0	54	6:45:00 AM	0	0	0	0	07:45	13	80	93	08:00	28	0	35	63
Peak Factor	0.787								0.793				0.675					

ALL TRAFFIC DATA INC.

(916)771-8700

FAX 786-2879

File Name : F-Barton-Rocklin

Site Code : 00000000

Start Date : 10/4/2006

Page No : 2

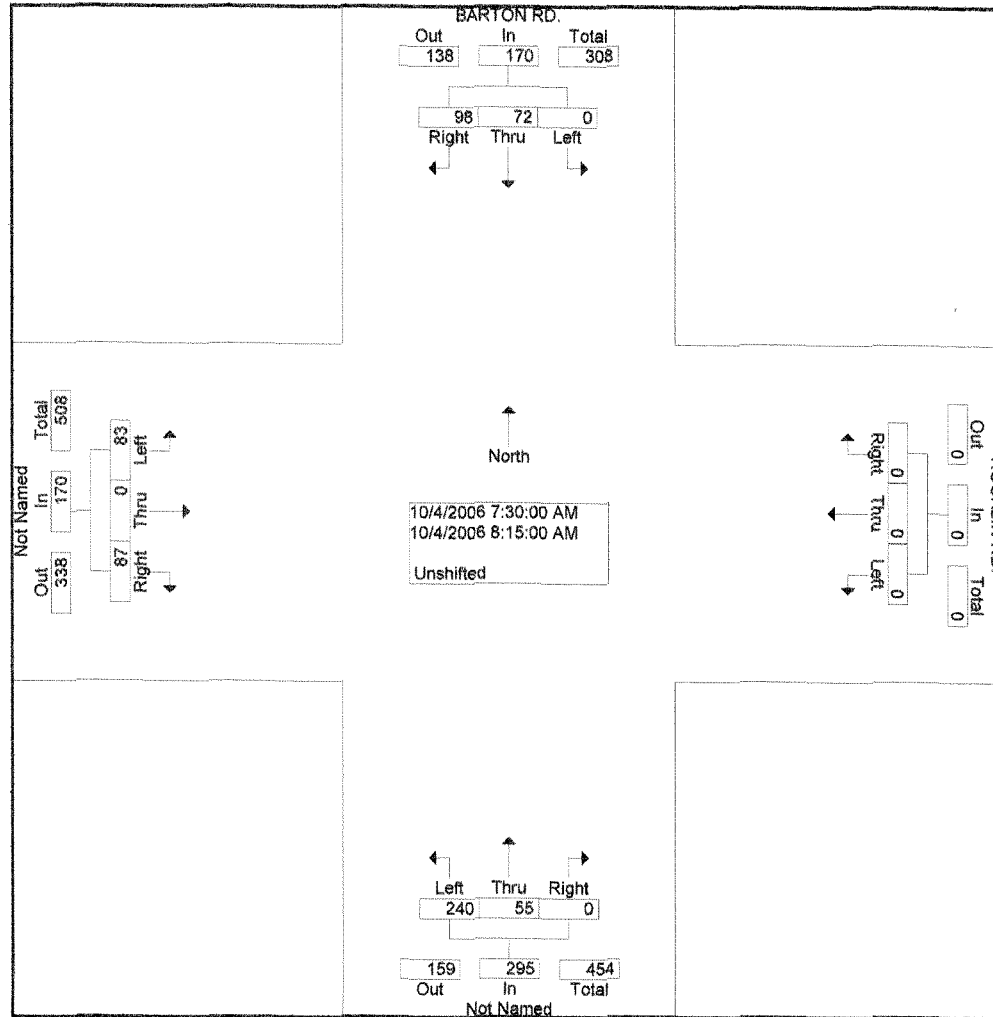

ALL TRAFFIC DATA INC.
 (916)771-8700
 FAX 786-2879

File Name : F-Barton-Rocklin
 Site Code : 00000000
 Start Date : 10/4/2006
 Page No : 3

Start Time	BARTON RD. Southbound				ROCKLIN RD. Westbound				Northbound				Eastbound				Int. Total			
	Right	Thru	Left	App. Total	Right	Thru	Left	App. Total	Right	Thru	Left	App. Total	Right	Thru	Left	App. Total				
Peak Hour From 16:00 to 17:45 - Peak 1 of 1																				
Intersection	16:15																			
Volume	55	43	0	98	0	0	0	0	0	68	153	221	242	0	61	303	622			
Percent	56.1	43.9	0.0		0.0	0.0	0.0		0.0	30.8	69.2		79.9	0.0	20.1					
17:00 Volume	9	12	0	21	0	0	0	0	0	20	31	51	88	0	20	108	180			
Peak Factor	0.864																			
High Int.	16:30																			
Volume	18	13	0	31	0	0	0	0	16:45	0	23	41	64	17:00	88	0	20	108		
Peak Factor	0.790												0.863				0.701			

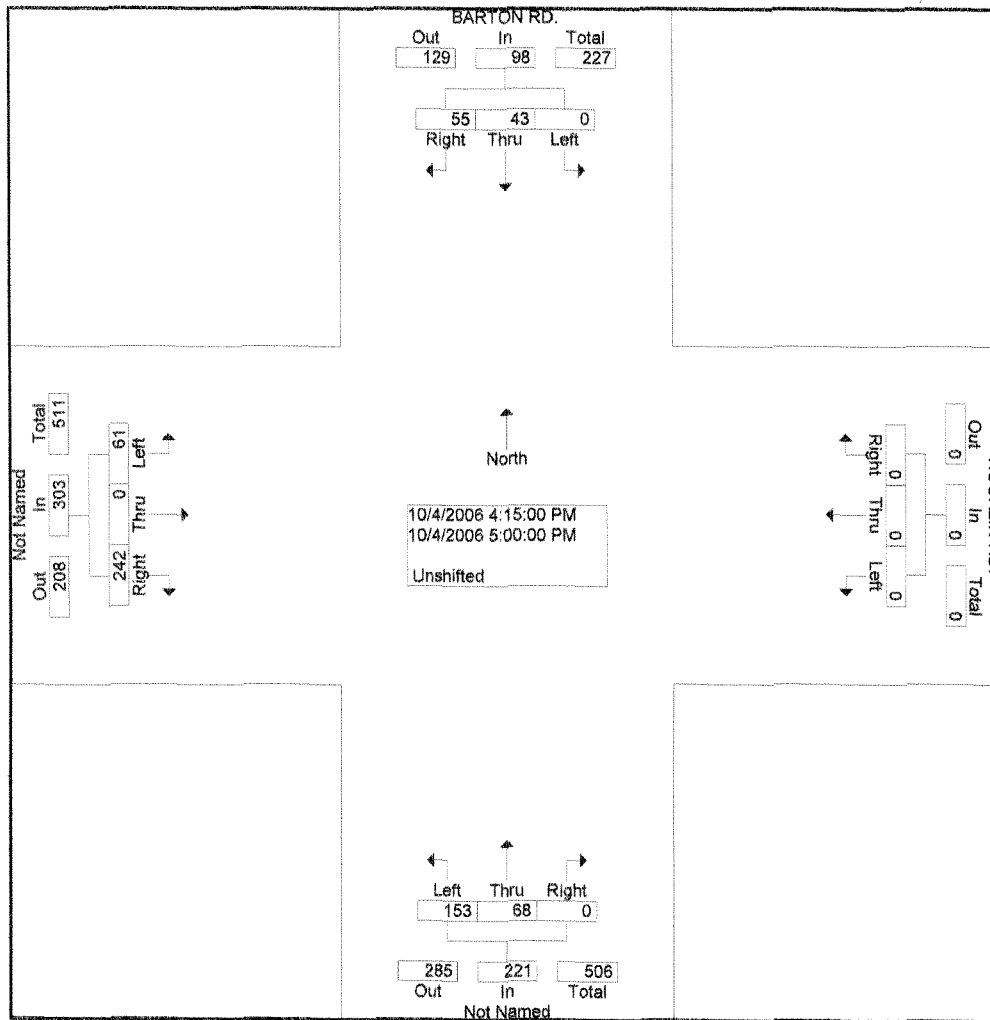

Intersection Turning Movement

Prepared by: Southland Car Counters

N-S STREET: Barton Rd

DATE: 08/19/2006

LOCATION: City of Rocklin

E-W STREET: Rocklin Rd.

DAY: SATURDAY

PROJECT# 06-7188-009

	NORTHBOUND			SOUTHBOUND			EASTBOUND			WESTBOUND			TOTAL
	NL	NT	NR	SL	ST	SR	EL	ET	ER	WL	WT	WR	
LANES:	0	1	0	0	1	0	0	1	0	0	0	0	

10:00 AM													
10:15 AM													
10:30 AM													
10:45 AM													
11:00 AM	24	6			3	7	5			22			67
11:15 AM	33	9			5	29	7			29			112
11:30 AM	26	6			4	44	8			36			124
11:45 AM	19	11			6	32	13			43			124
12:00 PM	20	16			12	25	17			34			124
12:15 PM	24	12			8	21	25			50			140
12:30 PM	22	9			12	18	20			46			127
12:45 PM	18	14			13	10	19			38			112
1:00 PM													
1:15 PM													
1:30 PM													
1:45 PM													
2:00 PM													
2:15 PM													
2:30 PM													
2:45 PM													

TOTAL VOLUMES =	NL 186	NT 83	NR 0	SL 0	ST 63	SR 186	EL 114	ET 0	ER 298	WL 0	WT 0	WR 0	TOTAL 930
-----------------	-----------	----------	---------	---------	----------	-----------	-----------	---------	-----------	---------	---------	---------	--------------

NOON Peak Hr Begins at: 1145 AM

PEAK VOLUMES =	85	48	0	0	38	96	75	0	173	0	0	0	515
PEAK HR. FACTOR:		0.924			0.882			0.827			0.000		0.920

CONTROL: Signalized

All Traffic Data, Inc.

(916) 771-8700

Fax 786-2879

PLACER COUNTY

File Name : SIERRA-KING-T

Site Code : 00000000

Start Date : 11/28/2006

Page No : 2

Start Time	SIERRA COLLEGE BLVD. Southbound				KING RD. Westbound				SIERRA COLLEGE BLVD. Northbound				KING RD. Eastbound				Int. Total
	Left	Thru	Right	App. Total	Left	Thru	Right	App. Total	Left	Thru	Right	App. Total	Left	Thru	Right	App. Total	
Peak Hour Analysis From 07:00 to 08:45 - Peak 1 of 1																	
Peak Hour for Entire Intersection Begins at 07:15																	
07:15	32	90	4	126	8	4	12	24	1	49	3	53	2	6	0	8	211
07:30	25	123	3	151	12	1	20	33	0	54	3	57	1	3	1	5	246
07:45	26	110	6	142	12	4	17	33	1	39	9	49	0	6	1	7	231
08:00	17	102	4	123	9	2	16	27	0	48	3	51	0	1	2	3	204
Total Volume	100	425	17	542	41	11	65	117	2	190	18	210	3	16	4	23	892
% App. Total	18.5	78.4	3.1		35	9.4	55.6		1	90.5	8.6		13	69.6	17.4		
PHF	.781	.864	.708	.897	.854	.688	.813	.886	.500	.880	.500	.921	.375	.667	.500	.719	.907

All Traffic Data, Inc.

(916) 771-8700

Fax 786-2879

PLACER COUNTY

File Name : SIERRA-KING-T

Site Code : 00000000

Start Date : 11/28/2006

Page No : 3

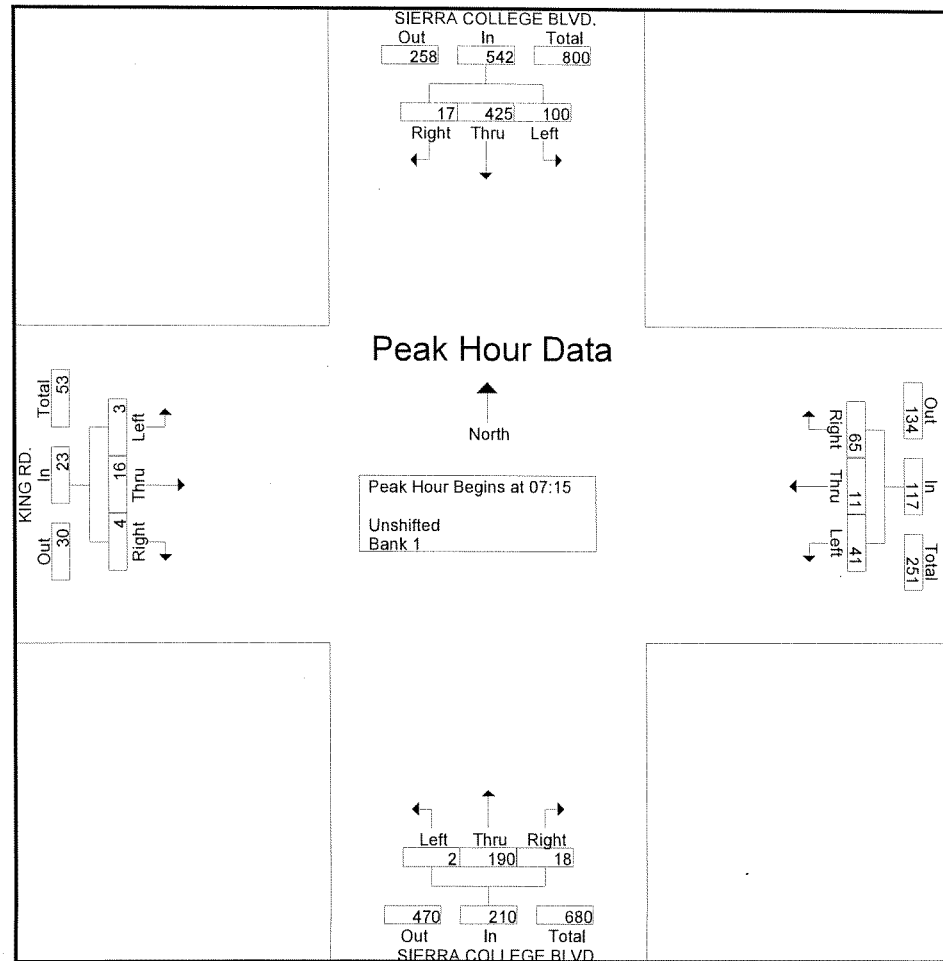

Peak Hour Analysis From 16:00 to 17:45 - Peak 1 of 1
Peak Hour for Entire Intersection Begins at 16:30

16:30	16	71	1	88	6	3	29	38	0	114	10	124	3	7	2	12	262
16:45	17	80	1	98	6	0	17	23	0	129	11	140	5	4	1	10	271
17:00	9	74	0	83	1	0	20	21	0	116	7	123	10	2	0	12	239
17:15	21	73	1	95	2	1	22	25	2	128	11	141	3	1	1	5	266
Total Volume	63	298	3	364	15	4	88	107	2	487	39	528	21	14	4	39	1038
% App. Total	17.3	81.9	0.8		14	3.7	82.2		0.4	92.2	7.4		53.8	35.9	10.3		
PHF	.750	.931	.750	.929	.625	.333	.759	.704	.250	.944	.886	.936	.525	.500	.500	.813	.958

All Traffic Data, Inc.

(916) 771-8700

Fax 786-2879

PLACER COUNTY

File Name : SIERRA-KING-T

Site Code : 00000000

Start Date : 11/28/2006

Page No : 4

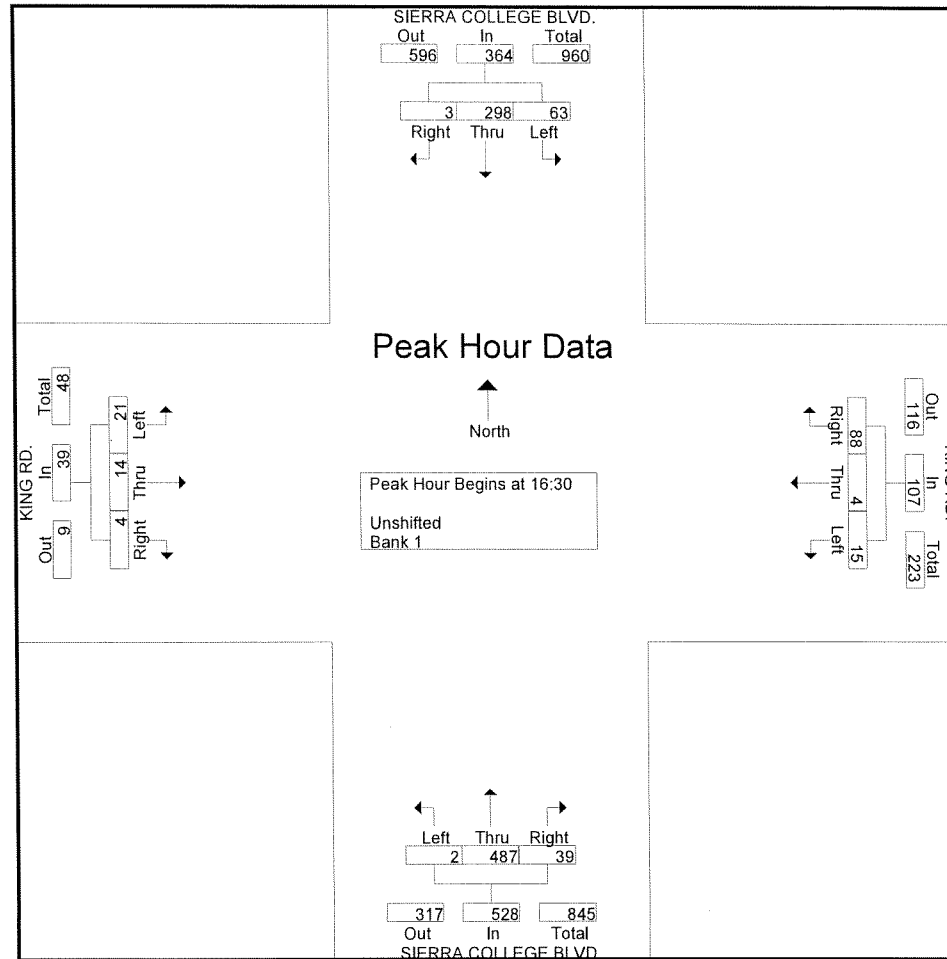

All Traffic Data Inc.

771-8700

FAX (916) 786-2879

PLACER COUNTY

File Name : KING-SIERRA-SAT

Site Code : 00000000

Start Date : 12/2/2006

Page No : 1

Groups Printed- Unshifted - Bank 1

Start Time	SIERRA COLLEGE BLVD. Southbound				KING RD. Westbound				SIERRA COLLEGE BLVD. Northbound				KING RD. Eastbound				Int. Total
	Right	Thru	Left	App. Total	Right	Thru	Left	App. Total	Right	Thru	Left	App. Total	Right	Thru	Left	App. Total	
11:00 AM	0	76	14	90	9	3	13	25	4	55	0	59	3	5	0	8	182
11:15 AM	0	80	9	89	17	1	11	29	3	79	0	82	1	3	1	5	205
11:30 AM	2	65	19	86	13	4	9	26	6	77	3	86	1	3	0	4	202
11:45 AM	0	68	8	76	8	2	5	15	6	56	3	65	3	3	1	7	163
Total	2	289	50	341	47	10	38	95	19	267	6	292	8	14	2	24	752
12:00 PM	2	71	11	84	15	2	2	19	5	56	0	61	1	1	2	4	168
12:15 PM	0	61	8	69	13	0	7	20	4	67	1	72	2	4	1	7	168
12:30 PM	0	61	18	79	9	3	4	16	5	66	1	72	2	0	0	2	169
12:45 PM	0	73	9	82	13	3	4	20	4	54	0	58	1	4	0	5	165
Total	2	266	46	314	50	8	17	75	18	243	2	263	6	9	3	18	670
Grand Total	4	555	96	655	97	18	55	170	37	510	8	555	14	23	5	42	1422
Apprch %	0.6	84.7	14.7		57.1	10.6	32.4		6.7	91.9	1.4		33.3	54.8	11.9		
Total %	0.3	39	6.8	46.1	6.8	1.3	3.9	12	2.6	35.9	0.6	39	1	1.6	0.4	3	
Unshifted	4	555	96	655	97	18	55	170	37	510	8	555	14	23	5	42	1422
% Unshifted	100	100	100	100	100	100	100	100	100	100	100	100	100	100	100	100	100
Bank 1	0	0	0	0	0	0	0	0	0	0	0	0	0	0	0	0	0
% Bank 1	0	0	0	0	0	0	0	0	0	0	0	0	0	0	0	0	0

Start Time	SIERRA COLLEGE BLVD. Southbound				KING RD. Westbound				SIERRA COLLEGE BLVD. Northbound				KING RD. Eastbound				Int. Total
	Right	Thru	Left	App. Total	Right	Thru	Left	App. Total	Right	Thru	Left	App. Total	Right	Thru	Left	App. Total	
Peak Hour Analysis From 11:00 AM to 12:45 PM - Peak 1 of 1																	
Peak Hour for Entire Intersection Begins at 11:00 AM																	
11:00 AM	0	76	14	90	9	3	13	25	4	55	0	59	3	5	0	8	182
11:15 AM	0	80	9	89	17	1	11	29	3	79	0	82	1	3	1	5	205
11:30 AM	2	65	19	86	13	4	9	26	6	77	3	86	1	3	0	4	202
11:45 AM	0	68	8	76	8	2	5	15	6	56	3	65	3	3	1	7	163
Total Volume	2	289	50	341	47	10	38	95	19	267	6	292	8	14	2	24	752
% App. Total	0.6	84.8	14.7		49.5	10.5	40		6.5	91.4	2.1		33.3	58.3	8.3		
PHF	.250	.903	.658	.947	.691	.625	.731	.819	.792	.845	.500	.849	.667	.700	.500	.750	.917

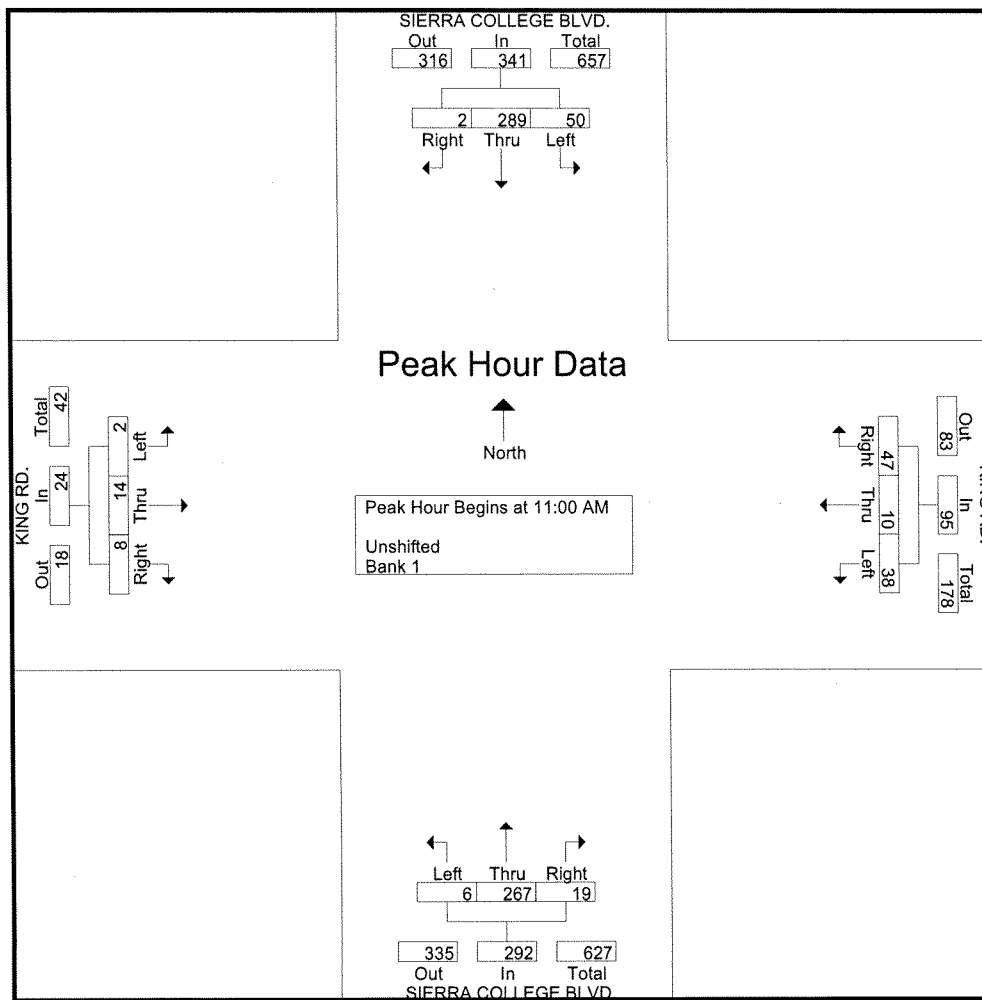

All Traffic Data, Inc.

(916) 771-8700

Fax 786-2879

PLACER COUNTY

File Name : SIERRA COLLEGE-ENGLISH-F

Site Code : 00000000

Start Date : 11/28/2006

Page No : 2

Start Time	SIERRA COLLEGE BLVD. Southbound				ENGLISH COLONY WAY Westbound				SIERRA COLLEGE BLVD. Northbound				ENGLISH COLONY WAY Eastbound				Int. Total
	Left	Thru	Right	App. Total	Left	Thru	Right	App. Total	Left	Thru	Right	App. Total	Left	Thru	Right	App. Total	
Peak Hour Analysis From 07:00 to 08:45 - Peak 1 of 1																	
Peak Hour for Entire Intersection Begins at 07:00																	
07:00	20	101	0	121	1	0	8	9	0	73	1	74	0	0	0	0	204
07:15	20	134	0	154	1	0	9	10	0	67	0	67	0	0	0	0	231
07:30	17	150	0	167	2	0	8	10	0	58	0	58	0	0	0	0	235
07:45	14	133	0	147	0	0	12	12	0	59	0	59	0	0	0	0	218
Total Volume	71	518	0	589	4	0	37	41	0	257	1	258	0	0	0	0	888
% App. Total	12.1	87.9	0		9.8	0	90.2		0	99.6	0.4		0	0	0		
PHF	.888	.863	.000	.882	.500	.000	.771	.854	.000	.880	.250	.872	.000	.000	.000	.000	.945

All Traffic Data, Inc.

(916) 771-8700

Fax 786-2879

PLACER COUNTY

File Name : SIERRA COLLEGE-ENGLISH-F

Site Code : 00000000

Start Date : 11/28/2006

Page No : 3

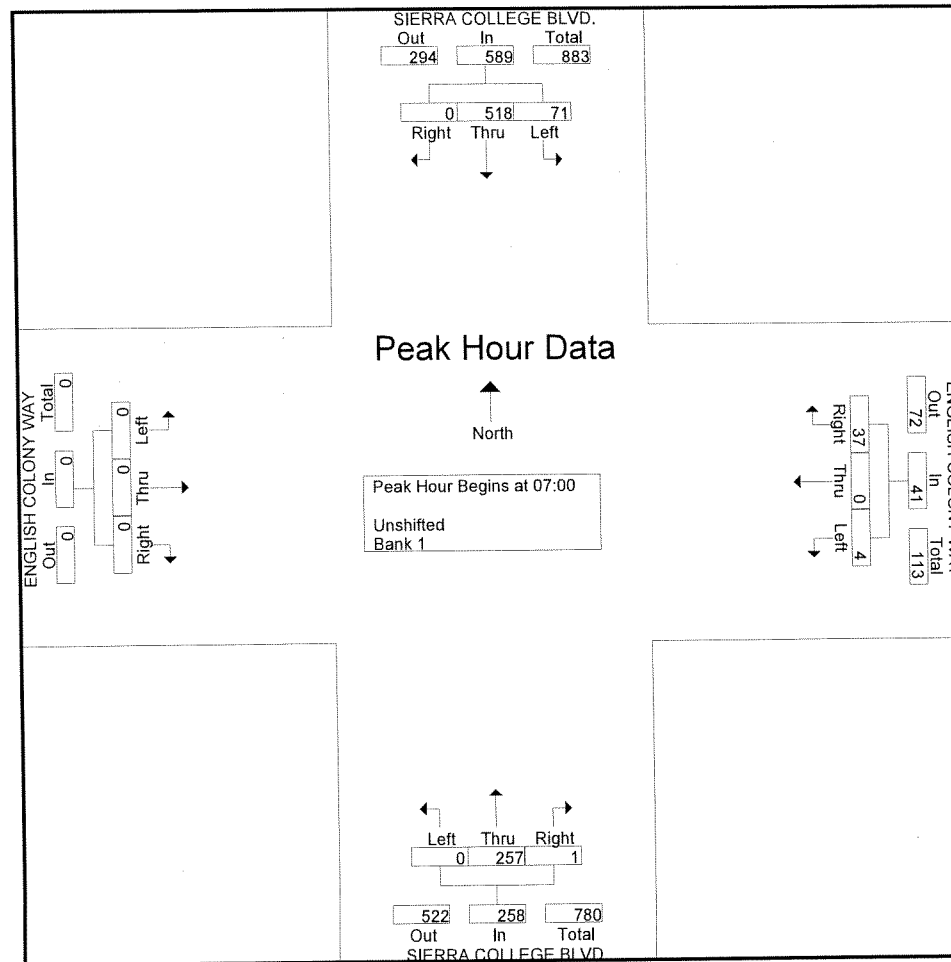

Peak Hour Analysis From 16:00 to 17:45 - Peak 1 of 1

Peak Hour for Entire Intersection Begins at 16:30

16:30	16	91	0	107	1	0	16	17	0	130	2	132	0	0	0	0	256
16:45	11	75	0	86	1	0	12	13	0	142	0	142	0	0	0	0	241
17:00	13	58	0	71	1	0	15	16	0	142	1	143	0	0	0	0	230
17:15	7	90	0	97	0	0	14	14	0	145	1	146	0	0	0	0	257
Total Volume	47	314	0	361	3	0	57	60	0	559	4	563	0	0	0	0	984
% App. Total	13	87	0	843	5	0	95	882	0	99.3	0.7	964	0	0	0	0	957
PHF	.734	.863	.000	.843	.750	.000	.891	.882	.000	.964	.500	.964	.000	.000	.000	.000	.957

All Traffic Data, Inc.

(916) 771-8700

Fax 786-2879

PLACER COUNTY

File Name : SIERRA COLLEGE-ENGLISH-F

Site Code : 00000000

Start Date : 11/28/2006

Page No : 4

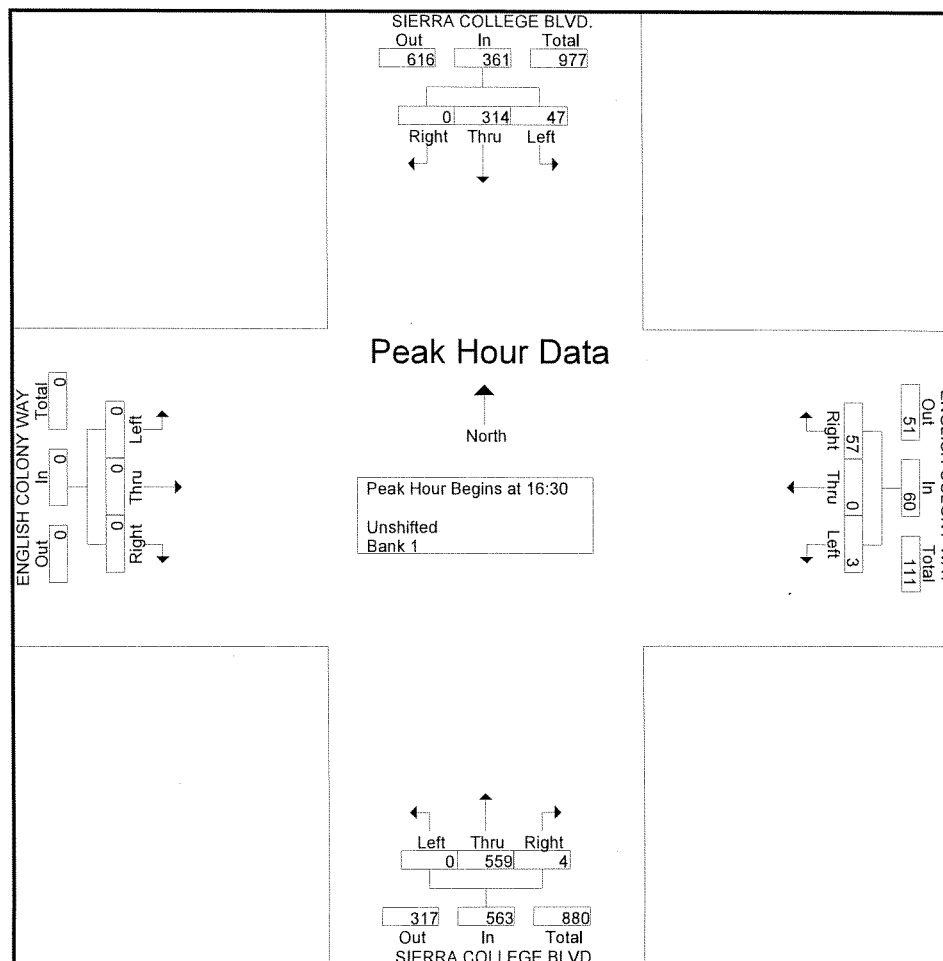

All Traffic Data Inc.

771-8700
FAX (916) 786-2879

File Name : SIERRA-ENGLISH-SAT
Site Code : 00000000
Start Date : 12/2/2006
Page No : 1

Groups Printed- Unshifted - Bank 1

Start Time	SIERRA COLLEGE BLVD. Southbound					ENGLISH COLONY WAY Westbound					SIERRA COLLEGE BLVD. Northbound					Eastbound					Int. Total
	Right	Thru	Left	Peds	App. Total	Right	Thru	Left	Peds	App. Total	Right	Thru	Left	Peds	App. Total	Right	Thru	Left	Peds	App. Total	
11:00 AM	0	78	12	0	90	5	0	1	0	6	0	58	0	0	58	0	0	0	0	0	154
11:15 AM	0	78	5	0	83	5	0	1	0	6	3	72	0	0	75	0	0	0	0	0	164
11:30 AM	0	61	10	0	71	6	0	1	0	7	1	79	0	0	80	0	0	0	0	0	158
11:45 AM	0	71	4	0	75	5	0	0	0	5	0	69	0	0	69	0	0	0	0	0	149
Total	0	288	31	0	319	21	0	3	0	24	4	278	0	0	282	0	0	0	0	0	625
12:00 PM	0	63	7	0	70	7	0	0	0	7	1	61	0	0	62	0	0	0	0	0	139
12:15 PM	0	66	9	0	75	2	0	0	0	2	1	83	0	0	84	0	0	0	0	0	161
12:30 PM	0	66	6	0	72	3	0	0	0	3	1	71	0	0	72	0	0	0	0	0	147
12:45 PM	0	80	9	0	89	8	0	1	0	9	1	54	0	0	55	0	0	0	0	0	153
Total	0	275	31	0	306	20	0	1	0	21	4	269	0	0	273	0	0	0	0	0	600
Grand Total	0	563	62	0	625	41	0	4	0	45	8	547	0	0	555	0	0	0	0	0	1225
Apprch %	0	90.1	9.9	0		91.1	0	8.9	0		1.4	98.6	0	0		0	0	0	0	0	
Total %	0	46	5.1	0	51	3.3	0	0.3	0	3.7	0.7	44.7	0	0	45.3	0	0	0	0	0	
Unshifted	0	563	62	0	625	41	0	4	0	45	8	547	0	0	555	0	0	0	0	0	1225
% Unshifted	0	100	100	0	100	100	0	100	0	100	100	100	0	0	100	0	0	0	0	0	100
Bank 1	0	0	0	0	0	0	0	0	0	0	0	0	0	0	0	0	0	0	0	0	0
% Bank 1	0	0	0	0	0	0	0	0	0	0	0	0	0	0	0	0	0	0	0	0	0

Start Time	SIERRA COLLEGE BLVD. Southbound					ENGLISH COLONY WAY Westbound					SIERRA COLLEGE BLVD. Northbound					Eastbound					Int. Total
	Right	Thru	Left	Peds	App. Total	Right	Thru	Left	Peds	App. Total	Right	Thru	Left	Peds	App. Total	Right	Thru	Left	Peds	App. Total	
11:00 AM	0	78	12	0	90	5	0	1	0	6	0	58	0	0	58	0	0	0	0	0	154
11:15 AM	0	78	5	0	83	5	0	1	0	6	3	72	0	0	75	0	0	0	0	0	164
11:30 AM	0	61	10	0	71	6	0	1	0	7	1	79	0	0	80	0	0	0	0	0	158
11:45 AM	0	71	4	0	75	5	0	0	0	5	0	69	0	0	69	0	0	0	0	0	149
Total Volume	0	288	31	0	319	21	0	3	0	24	4	278	0	0	282	0	0	0	0	0	625
% App. Total	0	90.3	9.7	0		87.5	0	12.5	0		1.4	98.6	0	0		0	0	0	0	0	
PHF	.000	.923	.646	.000	.886	.875	.000	.750	.000	.857	.333	.880	.000	.000	.881	.000	.000	.000	.000	.000	.953

Peak Hour Analysis From 11:00 AM to 12:45 PM - Peak 1 of 1

Peak Hour for Entire Intersection Begins at 11:00 AM

All Traffic Data Inc.

771-8700
FAX (916) 786-2879

File Name : SIERRA-ENGLISH-SAT
Site Code : 00000000
Start Date : 12/2/2006
Page No : 2

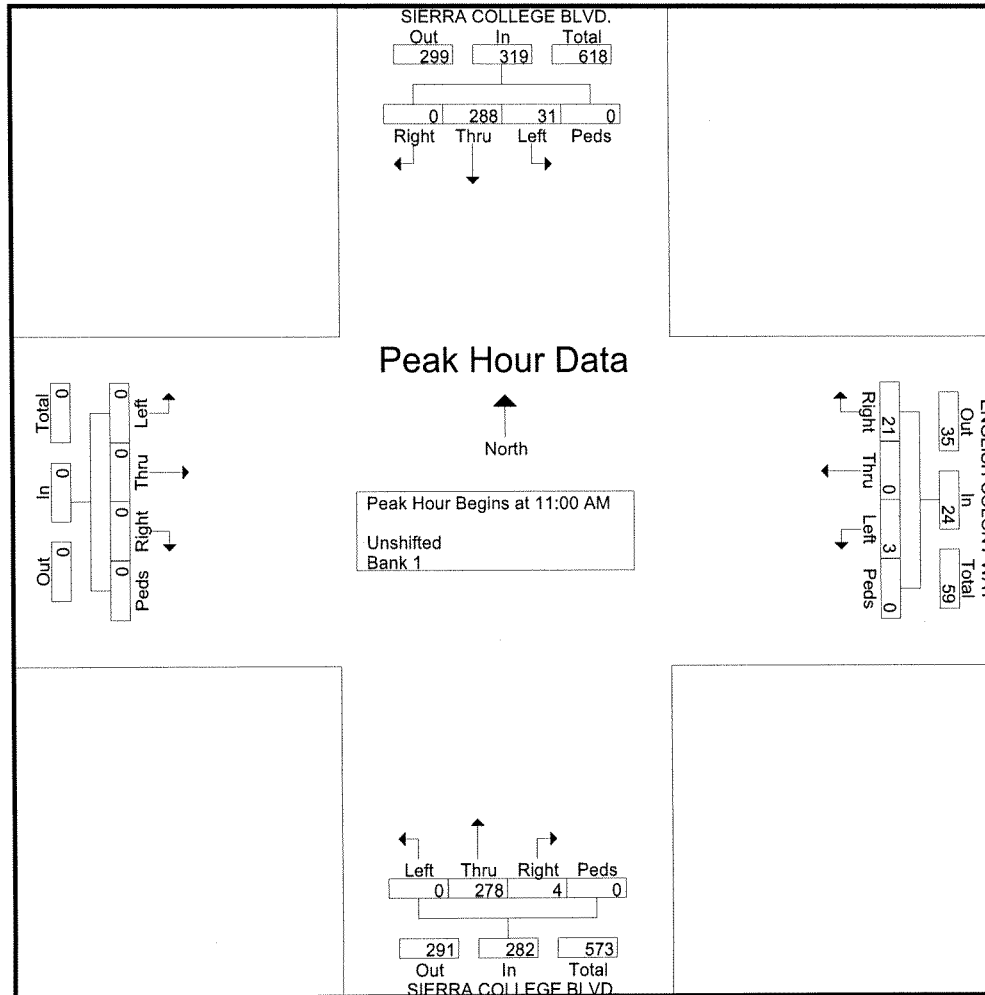

All Traffic Data, Inc.

(916) 771-8700

Fax 786-2879

PLACER COUNTY

File Name : KING-TAYLOR-T

Site Code : 00000000

Start Date : 11/28/2006

Page No : 1

Groups Printed- Unshifted - Bank 1

Start Time	TAYLOR RD. Southbound				KING RD Westbound				TAYLOR RD Northbound				KING RD Eastbound				Exclu. Total	Inclu. Total	Int. Total
	Left	Thru	Right	App. Total	Left	Thru	Right	App. Total	Left	Thru	Right	App. Total	Left	Thru	Right	App. Total			
07:00	11	50	22	61	10	12	20	42	68	73	8	149	40	16	61	117	22	369	391
07:15	17	71	25	88	17	19	34	70	58	126	13	197	73	16	40	129	25	484	509
07:30	14	99	35	113	30	30	53	113	43	118	22	183	73	32	66	171	35	580	615
07:45	18	103	45	121	46	41	12	99	60	59	24	143	25	32	75	132	45	495	540
Total	60	323	127	383	103	102	119	324	229	376	67	672	211	96	242	549	127	1928	2055
08:00	7	45	13	52	39	23	6	68	61	42	29	132	12	32	50	94	13	346	359
08:15	5	48	7	53	41	18	4	63	55	36	33	124	8	20	54	82	7	322	329
08:30	4	37	5	41	22	9	8	39	43	25	21	89	18	16	58	92	5	261	266
08:45	3	38	11	41	27	12	5	44	51	32	10	93	11	14	52	77	11	255	266
Total	19	168	36	187	129	62	23	214	210	135	93	438	49	82	214	345	36	1184	1220

*** BREAK ***

16:00	6	75	32	81	25	25	14	64	91	68	32	191	16	26	97	139	32	475	507
16:15	8	57	22	65	16	25	7	48	103	79	37	219	17	23	73	113	22	445	467
16:30	10	58	10	68	29	13	5	47	81	66	22	169	24	21	92	137	10	421	431
16:45	4	49	17	53	25	20	6	51	87	69	23	179	10	21	55	86	17	369	386
Total	28	239	81	267	95	83	32	210	362	282	114	758	67	91	317	475	81	1710	1791
17:00	7	71	18	78	38	28	2	68	58	80	32	170	19	39	88	146	18	462	480
17:15	9	38	10	47	40	31	9	80	63	63	28	154	17	29	68	114	10	395	405
17:30	8	39	10	47	25	15	4	44	57	70	43	170	20	31	52	103	10	364	374
17:45	5	49	13	54	24	17	9	50	47	65	26	138	8	14	39	61	13	303	316
Total	29	197	51	226	127	91	24	242	225	278	129	632	64	113	247	424	51	1524	1575
Grand Total	136	927	295	1063	454	338	198	990	1026	1071	403	2500	391	382	1020	1793	295	6346	6641
Apprch %	12.8	87.2			45.9	34.1	20		41	42.8	16.1		21.8	21.3	56.9				
Total %	2.1	14.6		16.8	7.2	5.3	3.1	15.6	16.2	16.9	6.4	39.4	6.2	6	16.1	28.3	4.4	95.6	
Unshifted	136	927		1358	454	338	198	990	1026	1071	403	2500	391	382	1020	1793	0	0	6641
% Unshifted	100	100	100	100	100	100	100	100	100	100	100	100	100	100	100	100	0	0	100
Bank 1	0	0		0	0	0	0	0	0	0	0	0	0	0	0	0	0	0	0
% Bank 1	0	0	0	0	0	0	0	0	0	0	0	0	0	0	0	0	0	0	0

Start Time	TAYLOR RD. Southbound				KING RD Westbound				TAYLOR RD Northbound				KING RD Eastbound				Int. Total
	Left	Thru	Right	App. Total	Left	Thru	Right	App. Total	Left	Thru	Right	App. Total	Left	Thru	Right	App. Total	
Peak Hour Analysis From 07:00 to 09:00 - Peak 1 of 1																	
Peak Hour for Entire Intersection Begins at 07:00																	
07:00	11	50		61	10	12	20	42	68	73	8	149	40	16	61	117	369
07:15	17	71		88	17	19	34	70	58	126	13	197	73	16	40	129	484
07:30	14	99		113	30	30	53	113	43	118	22	183	73	32	66	171	580
07:45	18	103		121	46	41	12	99	60	59	24	143	25	32	75	132	495
Total Volume	60	323		383	103	102	119	324	229	376	67	672	211	96	242	549	1928

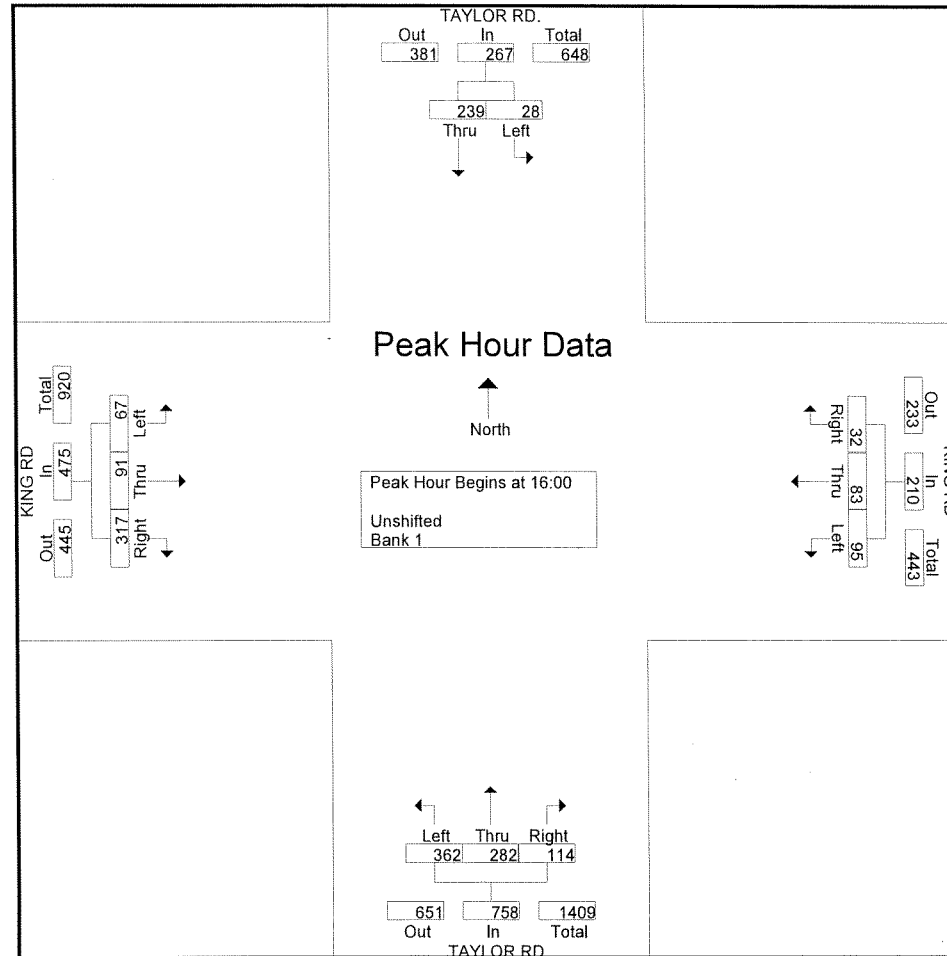

All Traffic Data Inc.

771-8700

FAX (916) 786-2879

PLACER COUNTY

File Name : TAYLOR-KING-SAT-F

Site Code : 00000000

Start Date : 12/2/2006

Page No : 1

Groups Printed- Unshifted - Bank 1

Start Time	TAYLOR RD. Southbound				KING RD. Westbound				TAYLOR RD. Northbound				KING RD. Eastbound				Int. Total
	Right	Thru	Left	App. Total	Right	Thru	Left	App. Total	Right	Thru	Left	App. Total	Right	Thru	Left	App. Total	
11:00 AM	8	42	6	56	2	14	35	51	21	47	32	100	32	12	11	55	262
11:15 AM	10	60	2	72	1	13	27	41	22	53	36	111	39	13	10	62	286
11:30 AM	15	75	5	95	7	11	30	48	23	65	39	127	40	13	17	70	340
11:45 AM	11	68	4	83	10	18	36	64	31	75	45	151	51	10	17	78	376
Total	44	245	17	306	20	56	128	204	97	240	152	489	162	48	55	265	1264
12:00 PM	9	51	6	66	2	16	24	42	29	67	32	128	42	13	11	66	302
12:15 PM	14	50	4	68	2	10	20	32	27	67	43	137	38	11	9	58	295
12:30 PM	6	50	4	60	7	12	19	38	20	59	29	108	33	12	13	58	264
12:45 PM	14	57	4	75	8	15	27	50	33	78	45	156	30	11	6	47	328
Total	43	208	18	269	19	53	90	162	109	271	149	529	143	47	39	229	1189
Grand Total	87	453	35	575	39	109	218	366	206	511	301	1018	305	95	94	494	2453
Apprch %	15.1	78.8	6.1		10.7	29.8	59.6		20.2	50.2	29.6		61.7	19.2	19		
Total %	3.5	18.5	1.4	23.4	1.6	4.4	8.9	14.9	8.4	20.8	12.3	41.5	12.4	3.9	3.8	20.1	
Unshifted	87	453	35	575	39	109	218	366	206	511	301	1018	305	95	94	494	2453
% Unshifted	100	100	100	100	100	100	100	100	100	100	100	100	100	100	100	100	100
Bank 1	0	0	0	0	0	0	0	0	0	0	0	0	0	0	0	0	0
% Bank 1	0	0	0	0	0	0	0	0	0	0	0	0	0	0	0	0	0

Start Time	TAYLOR RD. Southbound				KING RD. Westbound				TAYLOR RD. Northbound				KING RD. Eastbound				Int. Total
	Right	Thru	Left	App. Total	Right	Thru	Left	App. Total	Right	Thru	Left	App. Total	Right	Thru	Left	App. Total	
Peak Hour Analysis From 11:00 AM to 12:45 PM - Peak 1 of 1																	
Peak Hour for Entire Intersection Begins at 11:30 AM																	
11:30 AM	15	75	5	95	7	11	30	48	23	65	39	127	40	13	17	70	340
11:45 AM	11	68	4	83	10	18	36	64	31	75	45	151	51	10	17	78	376
12:00 PM	9	51	6	66	2	16	24	42	29	67	32	128	42	13	11	66	302
12:15 PM	14	50	4	68	2	10	20	32	27	67	43	137	38	11	9	58	295
Total Volume	49	244	19	312	21	55	110	186	110	274	159	543	171	47	54	272	1313
% App. Total	15.7	78.2	6.1		11.3	29.6	59.1		20.3	50.5	29.3		62.9	17.3	19.9		
PHF	.817	.813	.792	.821	.525	.764	.764	.727	.887	.913	.883	.899	.838	.904	.794	.872	.873

All Traffic Data Inc.

771-8700

FAX (916) 786-2879

PLACER COUNTY

File Name : TAYLOR-KING-SAT-F

Site Code : 00000000

Start Date : 12/2/2006

Page No : 2

