

Clover Valley Creek Velocity Profile 100-yr Storm Event (860 cfs)

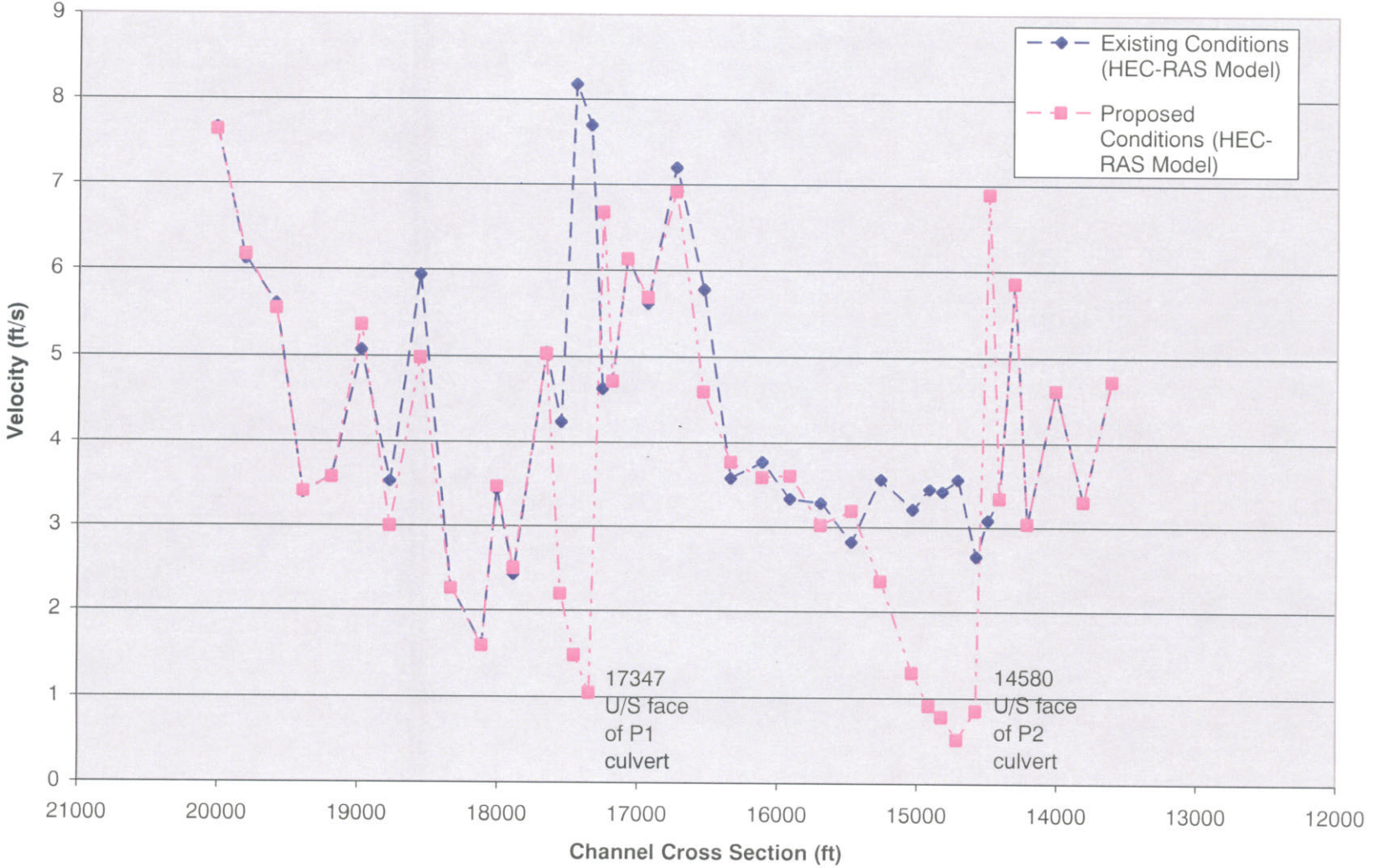

Clover Valley Creek Velocity Profile 10-yr Storm Event (400 cfs)

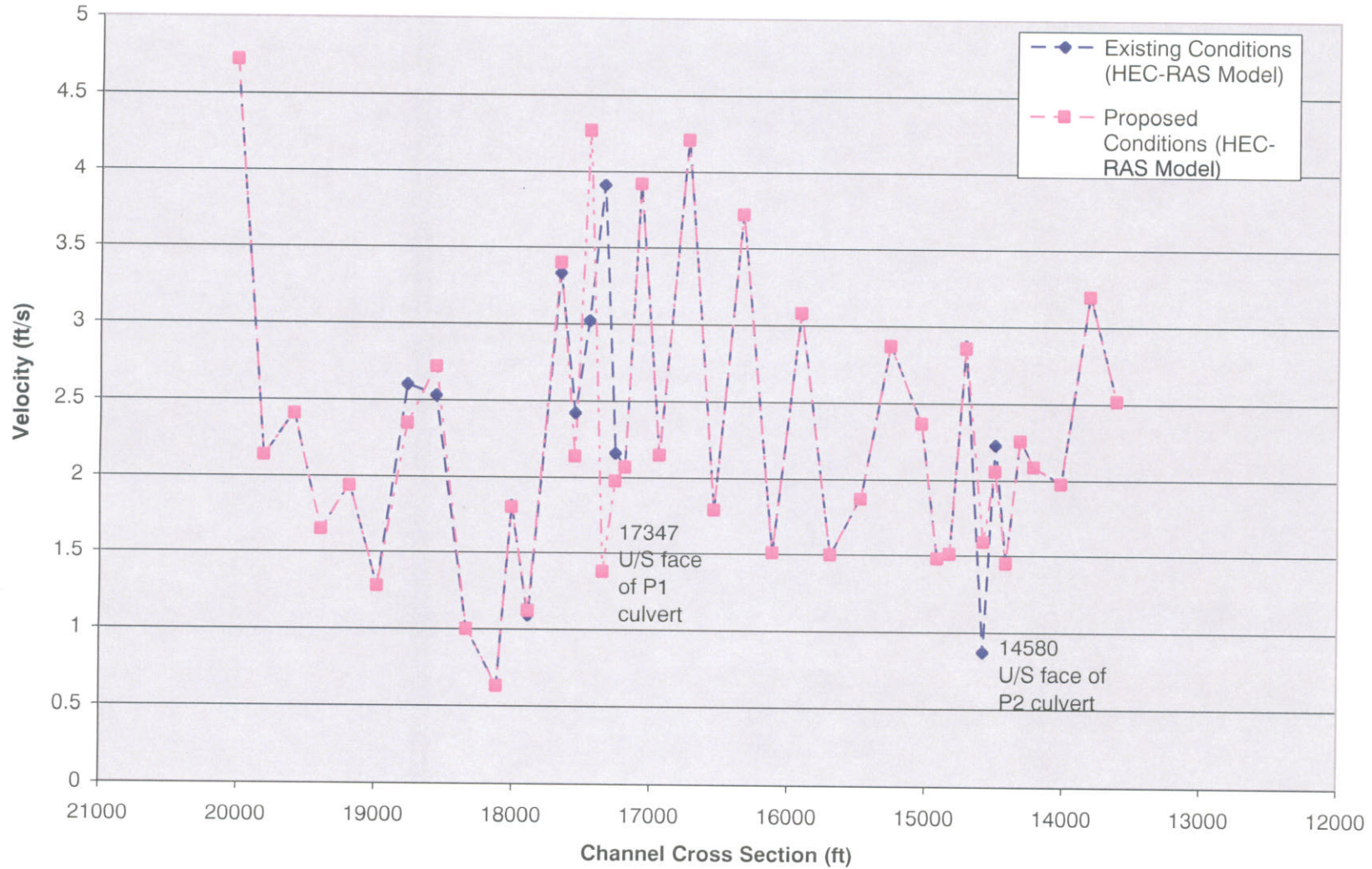

Clover Valley Creek Velocity Profile 4-yr Storm Event (200 cfs)

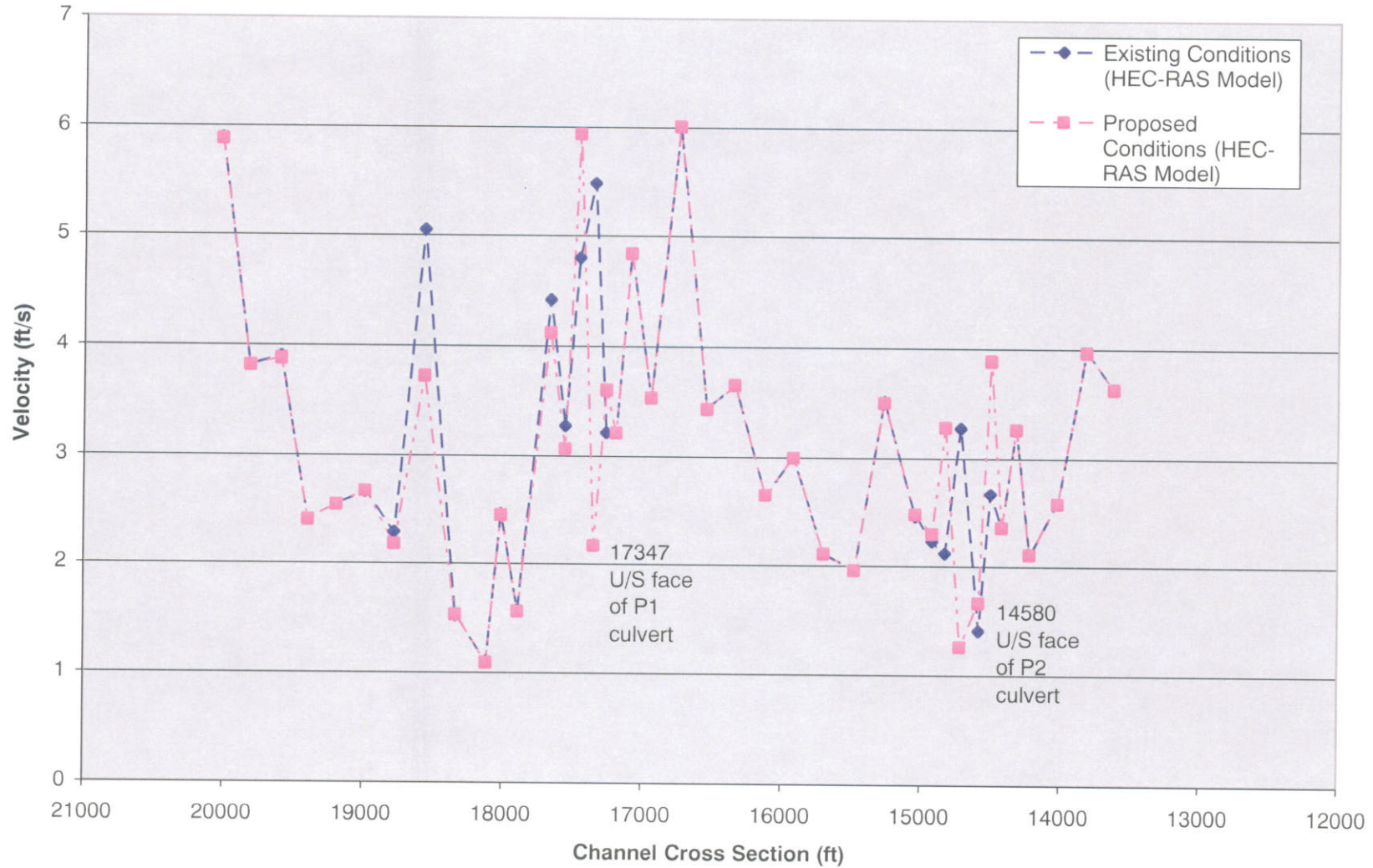

Clover Valley Creek Velocity Profile 2-yr Storm Event (100 cfs)

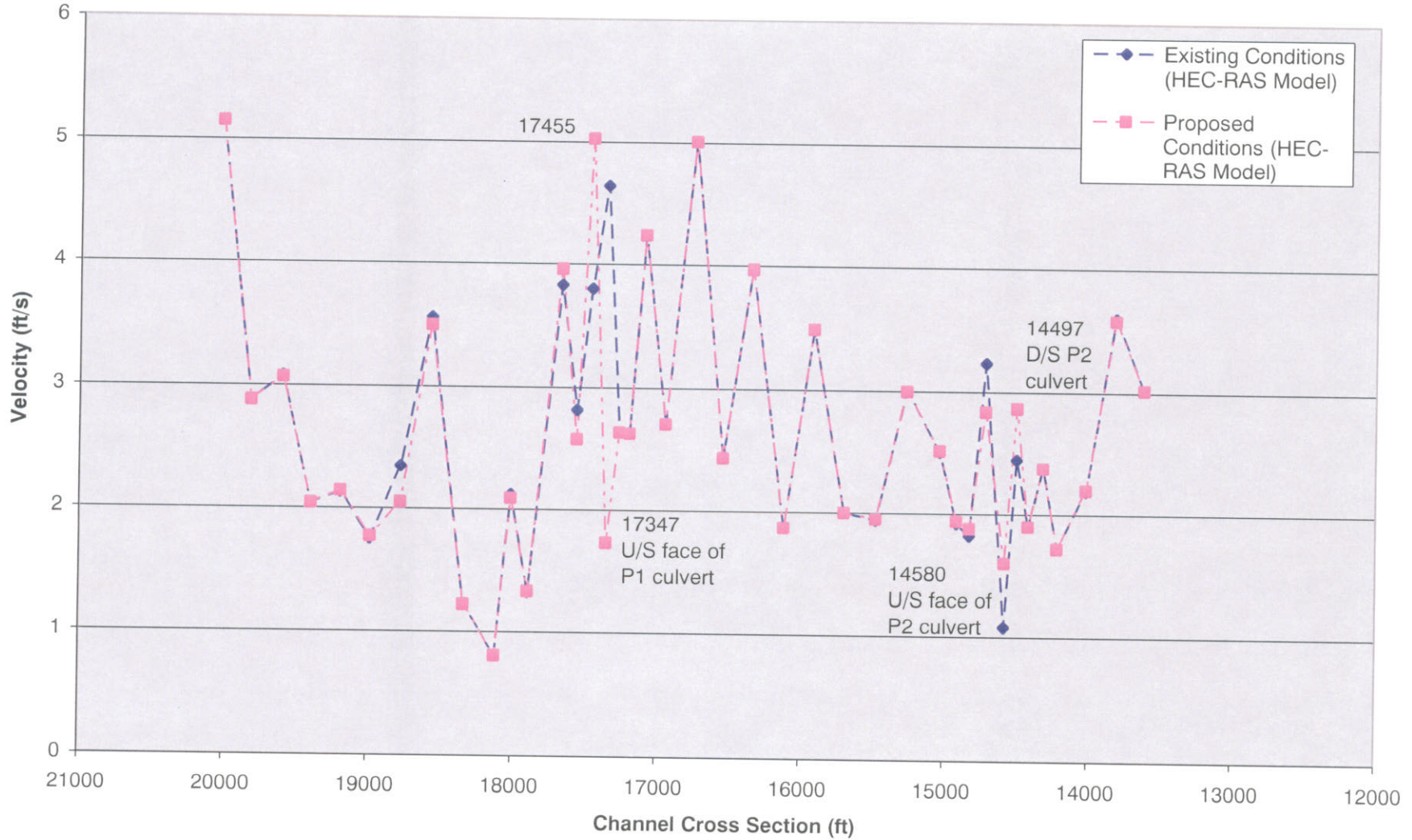

Clover Valley Creek Velocity Profile 1-yr Storm Event (50 cfs)

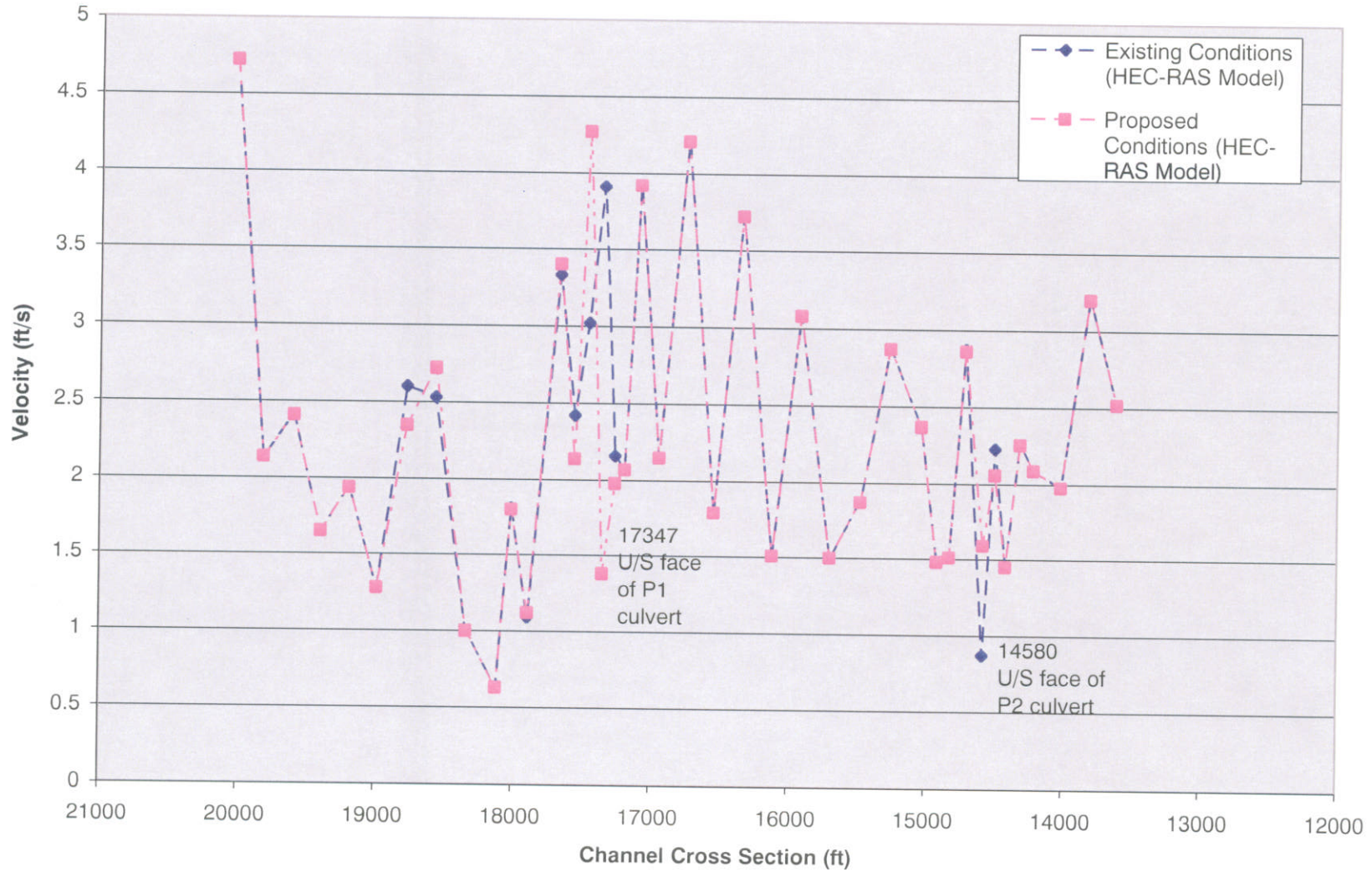

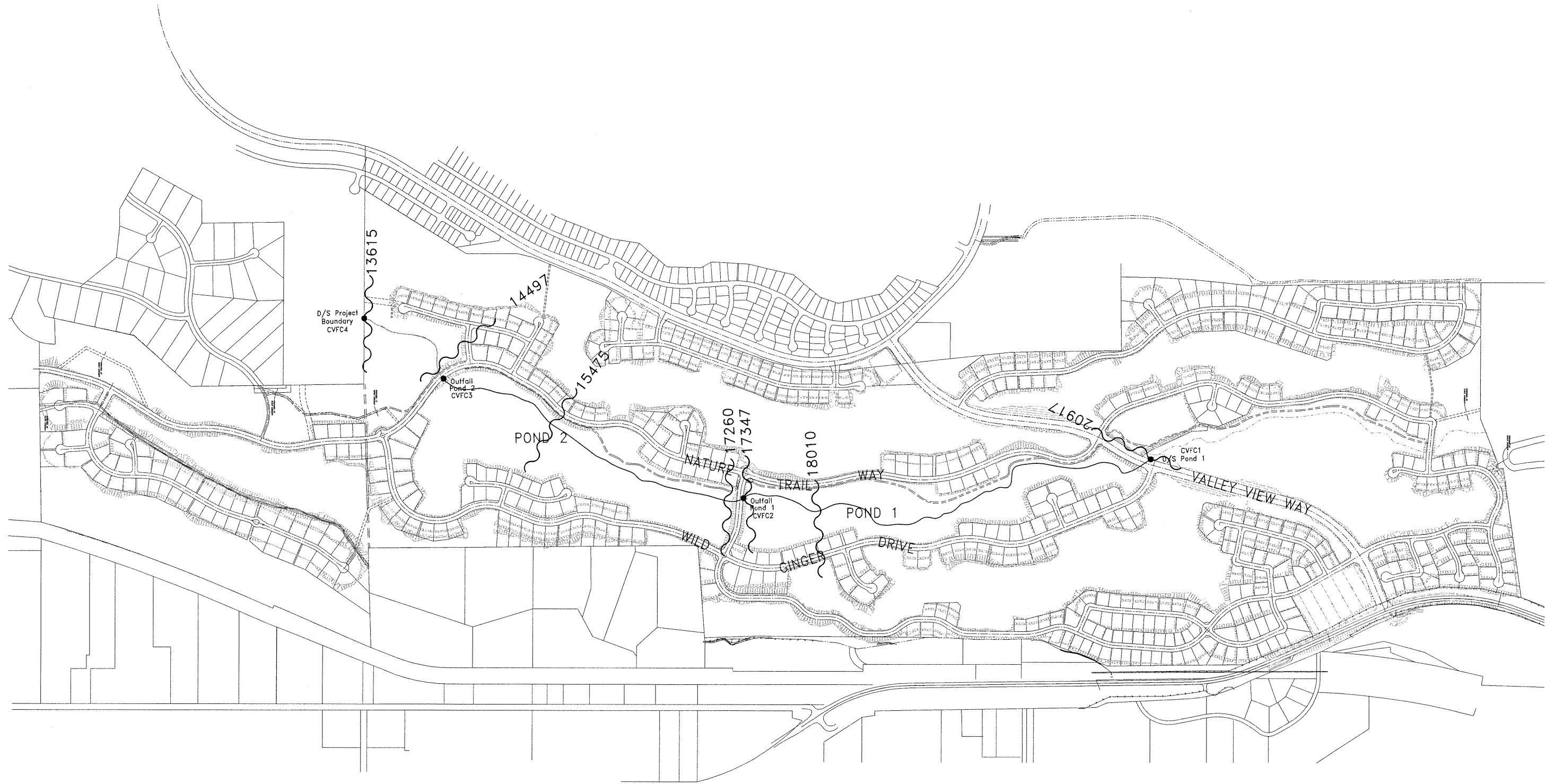

Client/Project
 CLOVER VALLEY PARTNERS
 CLOVER VALLEY

Title
**CREEK WATERSHED EXHIBIT
 CROSS-SECTION-LOCATIONS**
 JULY 2006
 84400042
 SCALE: 1:800

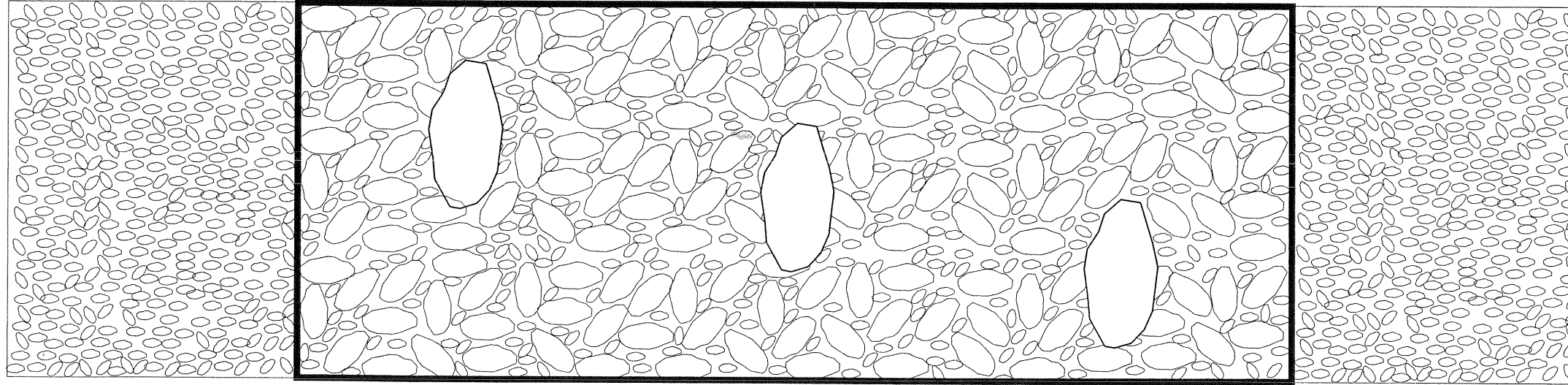
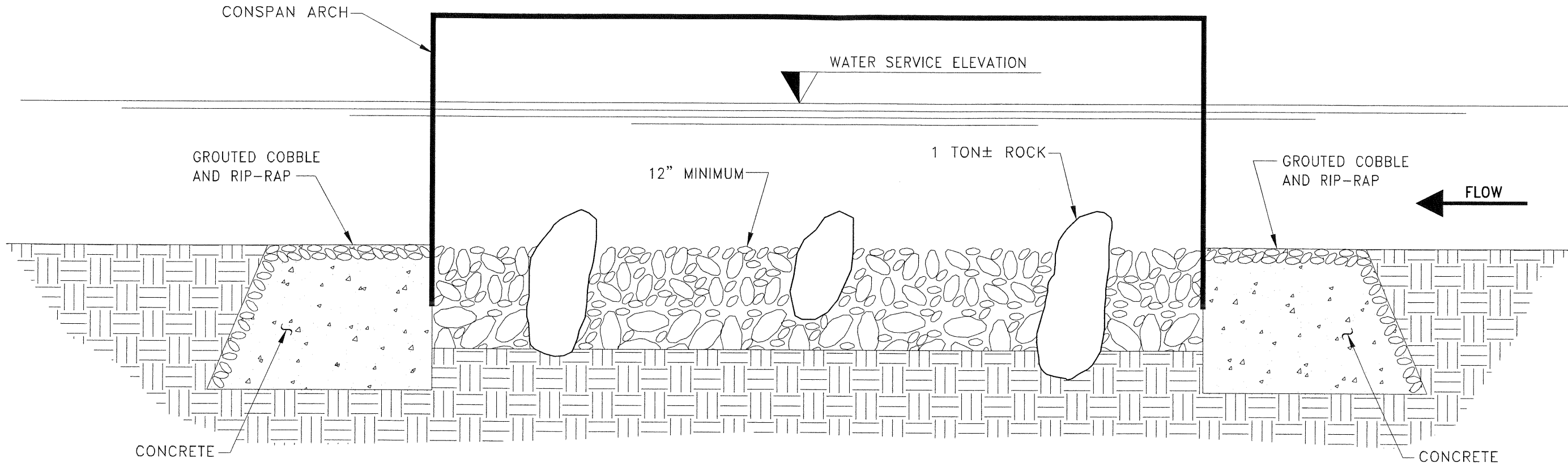

SCALE: NOT TO SCALE
 DATE: FEBRUARY 2007
 JOB NO. 844-38704

**CONCEPTUAL CREEK ARMORING
 AT CULVERT/ROAD CROSSING**

CLOVER VALLEY PARTNERS
CLOVER VALLEY
 CITY OF ROCKLIN, CALIFORNIA

Slantec Consulting Inc.
 2590 Venture Oaks Way
 Sacramento, CA 95833-3288
 Tel. 916.569.2500
 Fax. 916.921.9274
 www.slantec.com



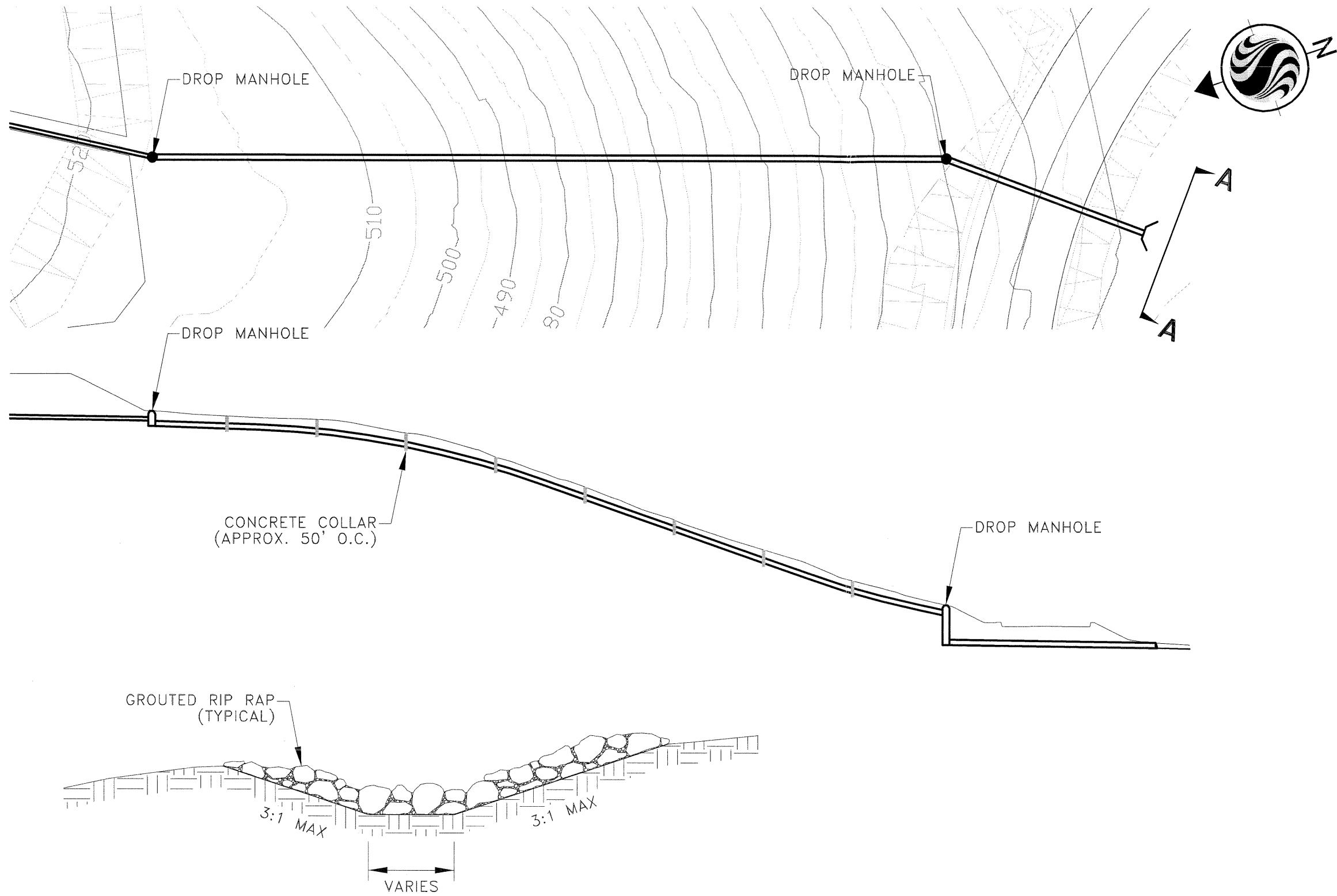

SECTION A-A

SCALE: N.T.S.

SHEET 1 OF 1
 SCALE: NOT TO SCALE
 DATE: FEBRUARY 2007
 JOB NO. 844-38704

CONCEPTUAL PIPED DRAINAGE
 ON A SLOPE

CLOVER VALLEY PARTNERS
CLOVER VALLEY
 CITY OF ROCKLIN, CALIFORNIA

StanTec Consulting Inc.
 2580 Venture Oaks Way
 Sacramento, CA 95833-3288
 Tel. 916.568.2500
 Fax. 916.921.9274
 www.stantec.com



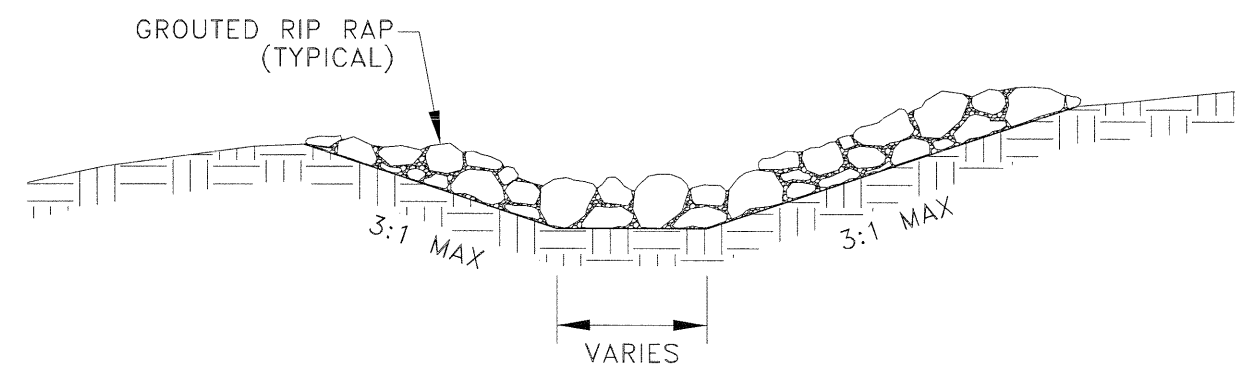
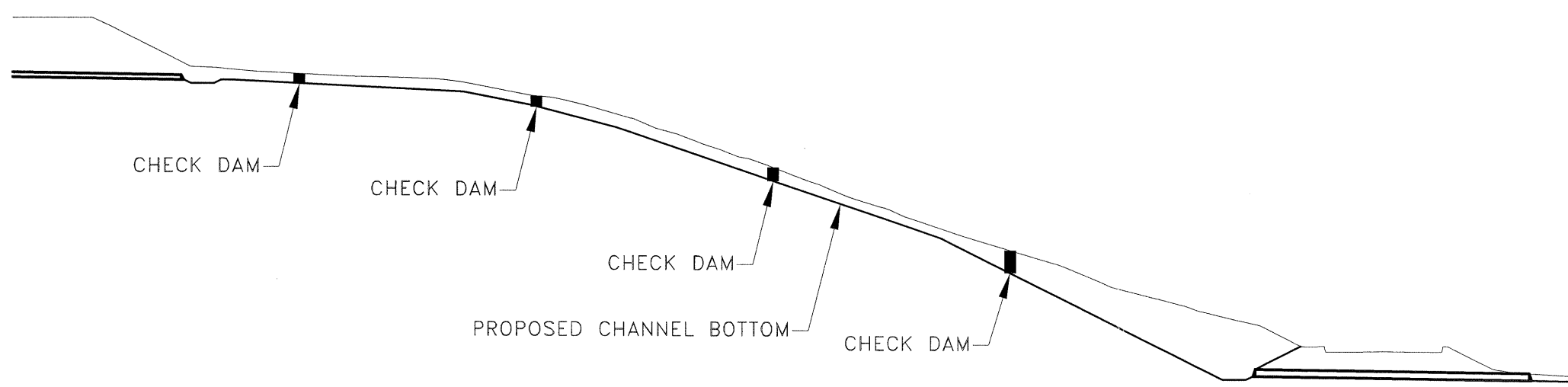
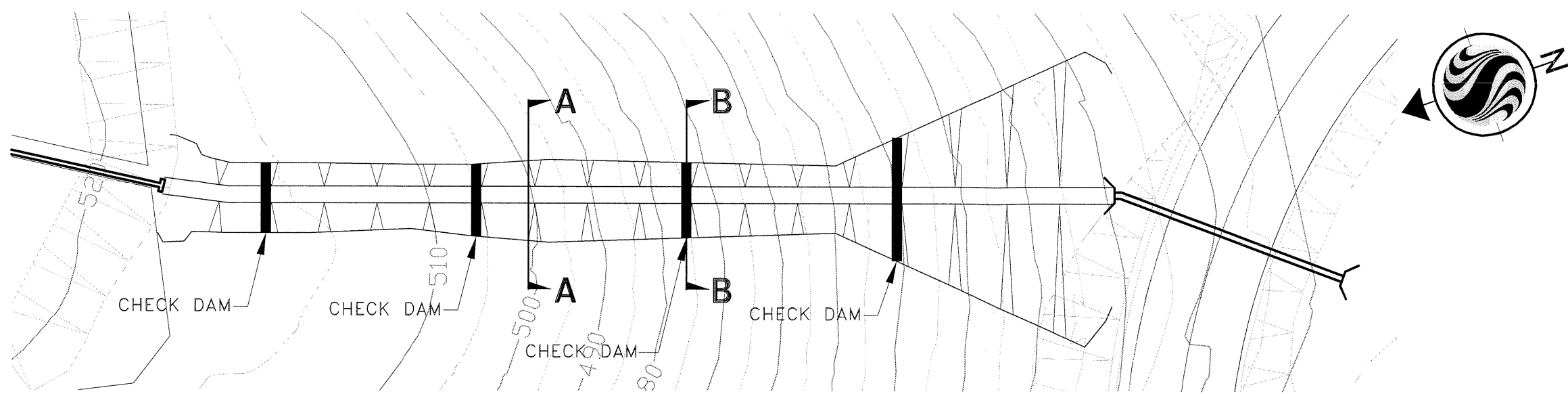

SECTION A-A

SCALE: N.T.S.

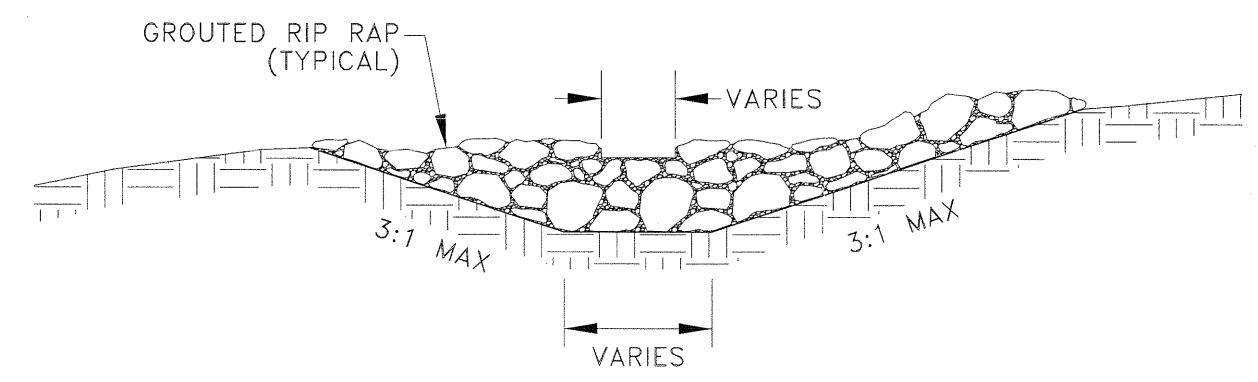

SECTION B-B

SCALE: N.T.S.

 Starline	V:\52844\active\84400042\civil\drawing\exhibits\slope-drainage\c-exh_drain-channel.dwg 3/01/07 7:34am cpruett
	Starline Consulting Inc. 2590 Venture Oaks Way Sacramento, CA 95833-3288 Tel. 916.569.2500 Fax. 916.921.9274 www.starline.com
CLOVER VALLEY CITY OF ROCKLIN, CALIFORNIA	CLOVER VALLEY PARTNERS
CONCEPTUAL DRAINAGE CHANNEL ON A SLOPE	SCALE: NOT TO SCALE DATE: FEBRUARY 2007 JOB NO. 844_38704
SHEET 1 OF 1	SHEET 1 OF 1

ATTACHMENT 2

Er Cud

1 yr, 2 yr, 4 yr

Clover Valley Existing Condition Plan: Plan 01 3/1/2007

CLOVER VALLEY LK

Legend	
—	Vel Chnl 4-yr
—	Vel Chnl 2-yr
—	Vel Chnl 1-yr
—	Vel Right 4-yr
—	Vel Left 4-yr
—	Vel Right 2-yr
—	Vel Left 2-yr
—	Vel Right 1-yr
—	Vel Left 1-yr

